

**POSTAL**<sup>®</sup>  
STEEL GROUP

## **STALOWE ELEMENTY KUTE** DO BRAM, OGRODZEŃ I BALUSTRAD

Forged steel components / Кованные элементы / Schmiedeeisen



30 lat  
**POSTAL**<sup>®</sup>  
STEEL GROUP

POSTAL STEEL GROUP POLSKA działa w branży metalowej od 30 lat. Oferujemy szeroką gamę stalowych elementów kutych do bram i ogrodzeń, a także elementy ze stali nierdzewnej i akcesoria spawalnicze. Naszym celem jest dostarczanie klientom produktów najwyższej jakości oraz zapewnienie doskonałego serwisu.

Zatrudniamy ponad 30 doświadczonych mobilnych i stacjonarnych handlowców, którzy pomagają klientom wybrać najlepsze produkty z naszego szerokiego asortymentu.

Cały czas pracujemy też nad poszerzeniem naszej oferty, tworząc marki takie jak:

POSTAL – stalowe elementy kute, PINOX – produkty ze stali nierdzewnej, PSG – akcesoria do bram i ogrodzeń, STARFLEX – tarcze do cięcia i szlifowania, STAR WIRE i PLATINIUM – druty i akcesoria spawalnicze.

Dbamy o najwyższą jakość powyższych marek, dlatego większość naszego towaru pochodzi z polskich i europejskich zakładów produkcyjnych, dzięki którym produkty są nieustannie doskonałe.

W Europie Środkowej jesteśmy liderem w swojej branży, a marka POSTAL jest szeroko znana w Polsce i poza nią. Dokładamy wszelkich starań, aby zawsze mogli Państwo polegać na jakości naszych usług i produktów.

POSTAL STEEL GROUP POLSKA has been operating in the metal industry for 30 years. We offer a wide range of forged steel components for gates and fences, as well as stainless steel elements and welding accessories. Since the very beginning our goal is to provide clients with the best possible service and highest quality products.

We employ over 30 experienced mobile and stationary advisers, who help our clients choose goods most suitable for them from our varied assortment.

We are constantly working on widening our offer by creating brands such as:

POSTAL – forged steel components, PINOX – stainless steel products, PSG – accessories for gates and fences, STARFLEX – cutting and grinding discs, STAR WIRE and PLATINIUM – welding wire and accessories.

To make sure that each brand offers the best quality products, we base major part of our production in our industrial plants based in Poland and Europe.

In Central Europe we are the leaders in our field and the brand POSTAL is well known in Poland and abroad. We will make every effort so that you associate our company and brands with the highest quality and reliability.



30<sup>lat</sup>  
**POSTAL**<sup>®</sup>  
STEEL GROUP

POSTAL STEEL GROUP POLSKA 30 лет работает в секторе металлургической промышленности. Мы предлагаем широкий ассортимент кованных стальных элементов для ворот и заборов, а также элементов из нержавеющей стали и сварочных аксессуаров. Наша цель – предоставить клиентам продукцию высокого качества и обеспечить отличный сервис.

У нас работает более 30 опытных мобильных и местных консультантов, которые помогают клиентам при выборе нужных продуктов из нашего ассортимента.

Мы также работаем над расширением нашего предложения, создавая такие бренды, как:

POSTAL – стальные кованные элементы, PINOX – изделия из нержавеющей стали, PSG – аксессуары для ворот и заборов, STARFLEX – диски для резки и шлифовки, STAR WIRE и PLATINIUM – высококачественные проволоки и аксессуары для сварки

Мы заботимся о высоком качестве этих брендов, поэтому большая часть наших продуктов поставляется на польских и европейских заводах, благодаря чему продукция постоянно совершенствуется.

В Центральной Европе мы являемся лидером в нашей отрасли, а бренд POSTAL широко известен в Польше и за рубежом.

POSTAL STEEL GROUP POLSKA ist seit 30 Jahren der Lieferant von hochwertigen Produkten in der Stahlbranche. Wir bieten breite Palette von sowohl Stahl- und Edelstahlelemente für Tore und Zäune als auch Schweißzubehör vor. Unser Ziel ist es, den Kunden Produkte von höchster Qualität zu liefern und einen exzellenten Kundenservice zu sichern.

Unser Team aus über 30 Mitarbeiterinnen und Mitarbeitern im Innen- und Außendienst berät kompetent und freundlich den Kunden bei der Wahl richtiger Produkten.

Wir arbeiten stets daran, damit unser Angebot sich erweitert und so sind folgende Marken entstanden wie:

POSTAL – geschmiedete Stahlelemente, PINOX – Edelstahlelemente, PSG – Zubehör für Tore und Zäune, STARFLEX – Schneid- und Schleifscheiben STAR WIRE und PLATINIUM – Schweißdrähte und Zubehör.

Wir achten auf die höchste Qualität der oben genannten Marken, deshalb kommt der größte Teil dieser Produkten von polnischen und europäischen Herstellern und wird ständig verbessert.

In Zentraleuropa sind wir führender Lieferant und die Marke POSTAL ist in Polen und im Ausland weithin bekannt. Wir streben uns danach, dass Sie sich auf die Qualität unserer Dienstleistungen und Produkte immer verlassen könnten.

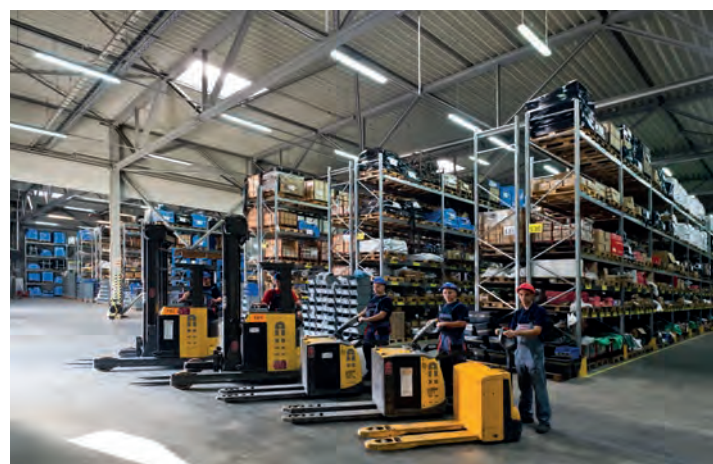

# NASI PARTNERZY

Our partners / Наши партнеры / Unsere Partner

W ofercie posiadamy asortyment czółowych producentów europejskich:

We provide products of leading european manufacturers:

Предлагаем аксессуары ведущих европейских производителей:

Wir bieten ein umfangreiches Sortiment von führenden europäischen Herstellern an:

**LOCINOX**

Okucia do ogrodzeń

Gate and fencing accessories /  
Фурнитура для ограждений /  
Baubeschläge für Zäune und Tore



**SEA**

Automatyka do bram

Gate automation /  
Автоматика для ворот /  
Torantriebe

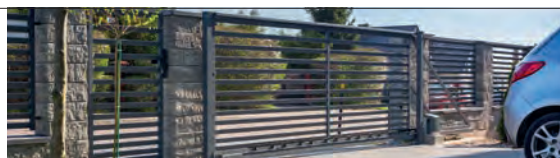

**BENINCA**  
AUTOMATYKA DO BRAM

Automatyka do bram

Gate automation /  
Автоматика для ворот /  
Torantriebe



**BFT**

Automatyka do bram

Gate automation /  
Автоматика для ворот /  
Torantriebe

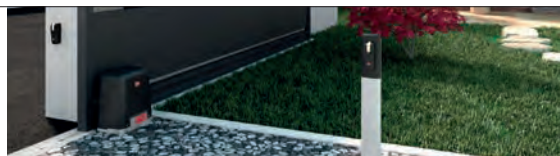

**CAME**

Automatyka do bram

Gate automation /  
Автоматика для ворот /  
Torantriebe



**FAAC**  
*Simply automatic.*

Automatyka do bram

Gate automation /  
Автоматика для ворот /  
Torantriebe



**Nice**

Automatyka do bram

Gate automation /  
Автоматика для ворот /  
Torantriebe



**ASSA ABLOY**

Zabezpieczenia

Security solutions /  
Sicherungen /  
Защита



**GATEMASTER**

Mechaniczne zamki i zaczepy

Mechanical locks and catches /  
Schlösser und Anschläge /  
Механические замки и защелки



**ABUS**  
Security Tech Germany

Technologie bezpieczeństwa

Security technologies /  
Sicherungs Technologien  
Технологии безопасности



# NASZE MARKI

Our brands / Наши бренды / Unsere Marken



**POSTAL**<sup>®</sup>  
STEEL GROUP

**Stalowe elementy kute**  
Forged steel components /  
Стальные кованные элементы /  
Die geschmiedete Stahlelemente



**BONMARIO**

**Sklep internetowy bonmario.com**  
Online Shop /  
Интернет-магазин /  
Online-Shop



**PINOX**

**Produkty ze stali nierdzewnej**  
Stainless steel products /  
Товары из нержавеющей стали /  
Produkten aus Edelstahl

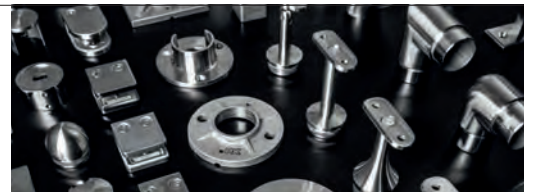

**PSG**

**Akcesoria do bram i ogrodzeń**  
Accessories for gates and fences /  
Аксессуары для ворот и ограждений /  
Zubehör für Tore und Zäune



**STAR FLEX**

**Tarcze do cięcia i szlifowania**  
Cutting and grinding discs /  
Диски для резки и шлифовки /  
Scheiben zum Schneiden und Schleifen

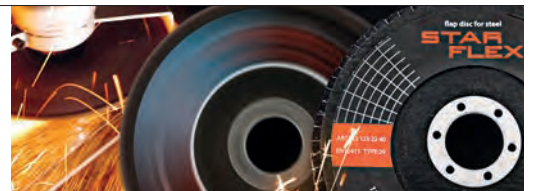

**STAR WIRE**

**Drut spawalniczy**  
Welding wire /  
Сварочная проволока /  
Schweißdraht



**Platinum**

**Drut spawalniczy**  
Welding wire /  
Сварочная проволока /  
Schweißdraht





# SATURN SUPER FAST 500 24V

**najszybszy** napęd  
do bramy przesuwnej

**#nr 1 na rynku**



**MOCNE WNĘTRZE! NAJWYŻSZA JAKOŚĆ!**



Produkty na zamówienie – skontaktuj się z biurem obsługi

Products available for special order - contact customer service /

Продукты доступны по специальному заказу – свяжитесь с продавцом /

Produkt auf Bestellung

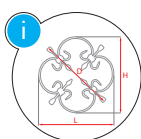

Spójne wymiarowanie produktów w kategoriach

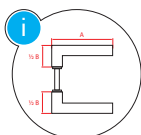

Dimensions measurements compatible in each category /

Соответствующие размеры продуктов в категориях /

Feste Bemaßung den Produkten in Kategorien

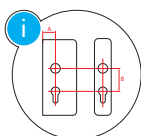

[mm]

Wszystkie wymiary podane w milimetrach

All dimensions in mm / Все параметры указаны в мм / Alle Abmessungen in mm

Zastrzega się możliwość zmian technologicznych lub odchyień od wymiarów. Produkty oryginalne mogą się różnić od przedstawionych na zdjęciach.

We inform that technological changes and size deviations of the products are possible.  
The original products might be different than the ones presented on the pictures.

Мы оставляем за собой право технологических изменений или отклонений от заданных размеров в каталоге.  
Оригинальный продукт может отличаться от приведенных на фотографиях.

Die Möglichkeit der technologischen Änderungen oder Abweichung von gegebenen Abmessungen im Katalog sind vorbehalten.  
Originelle Produkten können sich ansatzweise von den präsentierten Fotos unterscheiden

Wszystkie treści, materiały, zdjęcia oraz elementy graficzne umieszczone w niniejszym katalogu stanowią własność POSTAL STEEL GROUP POLSKA sp. z o.o. z siedzibą w Tarnowie Podgórnym („Spółka”) i są utworami w rozumieniu ustawy z dnia 4 lutego 1994 r. o prawie autorskim i prawach pokrewnych (t.j.: Dz. U. z 2018 r., poz. 1191 z późn. zm.). Żaden z powyższych utworów nie może być ani w całości, ani w części rozpowszechniany lub kopiowany w jakikolwiek sposób (elektroniczny, mechaniczny lub inny) bez zgody Spółki wyrażonej na piśmie pod rygorem nieważności. Jakiegokolwiek naruszenie uprawnień Spółki skutkować będzie wszczęciem czynności mających na celu uruchomienie środków ochrony prawnej przysługującej Spółce.

	10.089 - 11.332	<b>ELEMENTY SPIRALNE</b> scrolls / спиральные элементы / Spiralelemente	<b>11</b>
	12.010 - 12.150	<b>KOSZYKI</b> baskets / корзины / Zwirbeln	<b>19</b>
	13.000 - 13.323	<b>ROZETY</b> rosettes / розетки / Rosetten	<b>23</b>
	20.001 - 24.266	<b>TRALKI I SŁUPY</b> balusters and baluster posts / балясины / Stäbe und Brüstungspfosten	<b>43</b>
	30.001 - 31.404	<b>PŁASKOWNIKI I TAŚMY</b> flat bars and banding materials / полосы и ленты / Flacheisen und Hespeneisen	<b>55</b>
	30.020 - 34.231	<b>PROFILE ZAMKNIĘTE I PRĘTY OZDOBNE</b> bars and decorative bars / прутья и декоративные прутья / Vierkantrohre und decorative Stäbe	<b>63</b>
	40.001 - 40.300	<b>GROTY</b> spearheads / пики / Spitzen	<b>71</b>
	41.001 - 41.506	<b>PRZEKUWKI</b> ornamental steel collars/ насадки / Zierhülsen	<b>81</b>
	42.000 - 43.800.01	<b>GAŁKI I KULE</b> knobs and spheres / верхушки и шары / Pfostenaufsätze und Kugeln	<b>89</b>
	44.001 - 44.259.ZN	<b>MASKOWNICE</b> masking frames / маскировочные элементы / Abschlußrosetten	<b>95</b>
	50.000 - 51.452	<b>KWIATY I LIŚCIE</b> flowers and leaves / цветы и листья / Blumen und Blätter	<b>103</b>
	52.003 - 55.200	<b>ODLEWY STALIWNE I ŹELIWNE</b> cast steel items and cast iron items / литая сталь и чугунные элементы / Stahlguss und Gusseisenwaren	<b>123</b>
	56.010 - 56.090.12.01	<b>BLACHY</b> metal sheets / листовой металл / Stahlblech	<b>134</b>

	61.100 - 61.326	<b>ZAWIASY TOCZONE I PASOWE</b> hinges / петли / Scharniere und Ladenbänder	<b>139</b>
	62.101 - 62.104	<b>DASZKI</b> post caps / крышки / Deckel	<b>150</b>
	63.001 - 63.038	<b>KLAMKI I UCHWYTY</b> door handles / ручки / Türdrücker und Griffe	<b>153</b>
	63.040 - 63.194.90.00	<b>SZYLDY</b> shields / накладки / Schlosskastenblenden	<b>161</b>
	64.003 - 64.801	<b>AKCESORIA MOCUJĄCE</b> fixing elements / крепления / Befestigungszubehör	<b>168</b>
	65.200 - 65.259	<b>SKRZYNKI NA LISTY</b> mail boxes / почтовые ящики / Briefkästen	<b>173</b>
	66.003.01 - 66.006.01	<b>LAMPY</b> lamps / лампы / Lampen	<b>177</b>
	66.050 - 66.075	<b>NOGI DO ŁAWEK</b> bench legs / ножки для скамеек / Bankfüße	<b>178</b>
	70.001 - 70.123	<b>FARBY I PATYNY</b> paints and patinas / краски и патины / Farben und Patine	<b>181</b>
	71.001 - 75.041.01	<b>KOTWY I AKCESORIA</b> anchors and accessories / хемические анкера / Anker und Zubehör	<b>186</b>
	SP.001.08 - SWM.UCHWYT.01	<b>DRUT I AKCESORIA SPAWALNICZE</b> welding wire and accessories / сварочная проволока и принадлежности / Schweißdraht und Schweißzubehör	<b>189</b>
	TCI 115 10 22 - TZI 230 60 22	<b>TARCZE</b> discs / диски / Trennscheiben	<b>196</b>



# ELEMENTY SPIRALNE

scrolls  
спиральные элементы  
Spiralelemente



10.089 - 11.332

POSTAL<sup>®</sup>

# ELEMENTY SPIRALNE

scrolls / спиральные элементы / Spiralelemente



**N**

□	12x6	12x6	12x6	12x6	12x6	12x6	12x6	12x6	12x6	12x6	12x6
H	105	110	80	95	100	115	120	130	150	160	220
L	64	64	50	60	60	75	70	70	75	80	120
N°	<b>10.089</b>	<b>10.090</b>	<b>10.091</b>	<b>10.092</b>	<b>10.093</b>	<b>10.094</b>	<b>10.095</b>	<b>10.096</b>	<b>10.097</b>	<b>10.098</b>	<b>10.099</b>



□	12x6	12x6	12x6	12x6	12x6	12x6	12x6
H	150	230	260	170	195	300	330
L	70	115	115	80	90	120	130
N°	<b>10.100</b>	<b>10.101</b>	<b>10.102</b>	<b>10.103</b>	<b>10.104</b>	<b>10.107</b>	<b>10.108</b>

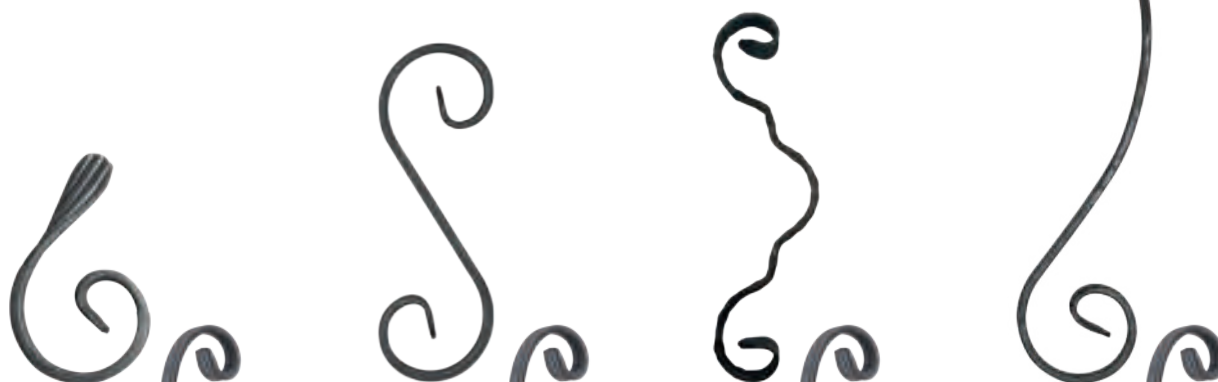

□	12x6	12x6	12x6	12x6
H	120	230	250	460
L	80	80	75	80
N°	<b>10.109</b>	<b>10.116</b>	<b>10.125</b>	<b>10.130</b>

# ELEMENTY SPIRALNE

scrolls / спиральные элементы / Spiralemente

13



□	12x6	12x6	12x6	12x6	12x6	12x6
H	80	100	120	130	160	220
L	55	60	75	75	80	130
N°	<b>10.200</b>	<b>10.201</b>	<b>10.202</b>	<b>10.203</b>	<b>10.204</b>	<b>10.205</b>



□	12x6	12x6	12x6	12x6	12x6	12x6
H	150	170	220	270	300	330
L	70	80	100	110	120	130
N°	<b>10.206</b>	<b>10.207</b>	<b>10.208</b>	<b>10.209</b>	<b>10.210</b>	<b>10.211</b>



# ELEMENTY SPIRALNE

scrolls / спиральные элементы / Spiralelemente

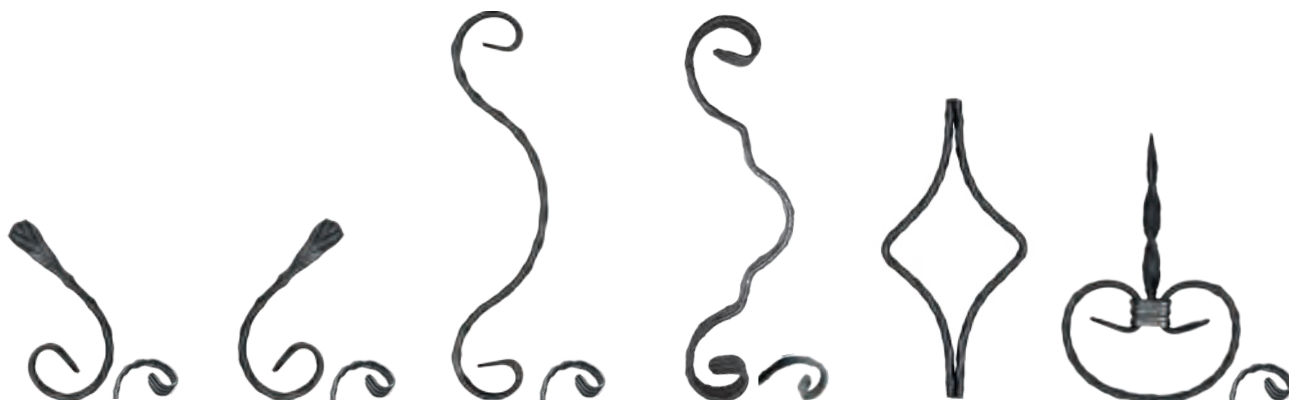

□	12x6	12x6	12x6	12x6	12x6	12x6
H	120	120	260	260	200	180
L	60	60	65	75	100	120
N°	<b>10.215</b>	<b>10.216</b>	<b>10.220</b>	<b>10.221</b>	<b>10.224</b>	<b>10.226</b>



□	12x6	12x6	12x6	12x6
H	100	120	150	150
L	180	220	100	100
N°	<b>10.230</b>	<b>10.231</b>	<b>10.240</b>	<b>10.241</b>



□	12x6	12x6	12x6	12x6
H	190	190	150	150
L	140	140	100	100
N°	<b>10.242</b>	<b>10.243</b>	<b>10.250</b>	<b>10.251</b>

# ELEMENTY SPIRALNE

scrolls / спиральные элементы / Spiralemente



□	12x12	12x12	12x12	12x12	12x12	12x12
H	100	120	130	150	190	220
L	70	75	80	82	123	128
N°	<b>10.300</b>	<b>10.301</b>	<b>10.302</b>	<b>10.303</b>	<b>10.304</b>	<b>10.305</b>



□	12x12	12x12	12x12	12x12
H	180	250	260	290
L	88	120	120	120
N°	<b>10.310</b>	<b>10.311</b>	<b>10.312</b>	<b>10.313</b>



# ELEMENTY SPIRALNE

scrolls / Spiralelemente / спиральные элементы / spirálové elementy



□	12x12	12x12	12x12
H	200	300	360
L	90	100	120
N°	<b>10.315</b>	<b>10.316</b>	<b>10.317</b>



□	12x12	12x12	12x12
H	125	135	175
L	65	65	95
N°	<b>10.320</b>	<b>10.321</b>	<b>10.323</b>



□	12x12	12x12	12x12
H	280	450	150
L	80	90	80
N°	<b>10.328</b>	<b>10.330</b>	<b>10.340</b>

# ELEMENTY SPIRALNE

scrolls / спиральные элементы / Spiralelemente



□	12x6	12x6	12x6	12x6	12x6
H	∅ 110	∅ 100	∅ 120	∅ 100	∅ 120
N°	<b>11.030</b>	<b>11.031</b>	<b>11.032</b>	<b>11.041</b>	<b>11.042</b>

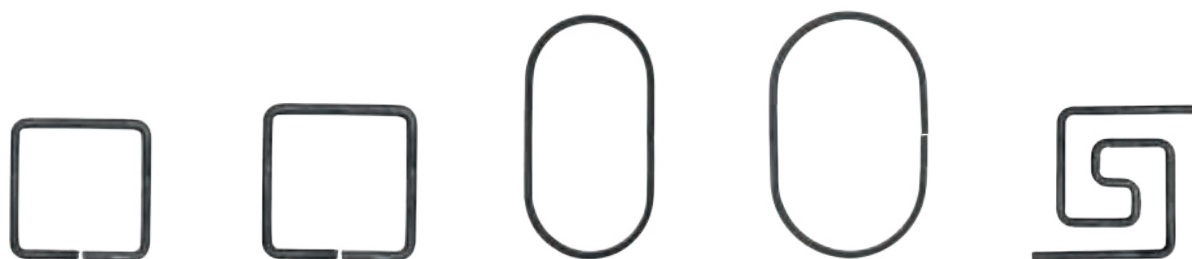

□	12x6	12x6	12x6	12x6	11,5x5,5
H	80	100	190	190	100
L	80	100	100	120	115
N°	<b>11.051</b>	<b>11.052</b>	<b>11.061</b>	<b>11.062</b>	<b>11.091</b>

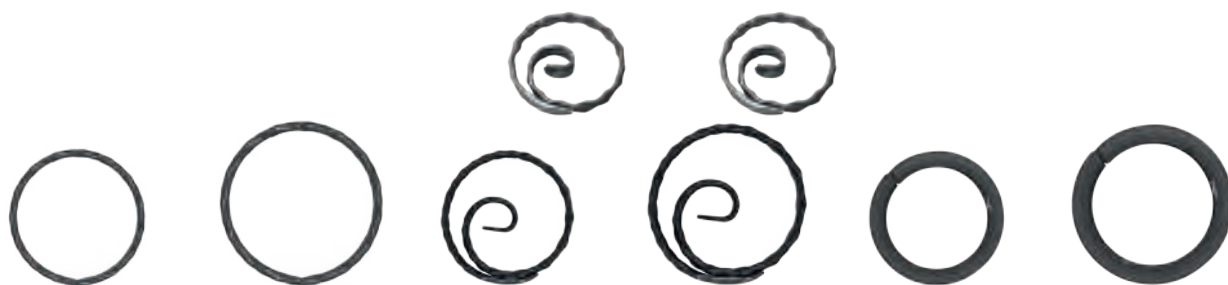

□	12x6	12x6	12x6	12x6	12x12	12x12
H	∅ 100	∅ 120	∅ 100	∅ 120	∅ 100	∅ 120
N°	<b>11.231</b>	<b>11.232</b>	<b>11.241</b>	<b>11.242</b>	<b>11.331</b>	<b>11.332</b>



# KOSZYKI

baskets  
корзины  
Zwirbeln



12.010 - 12.150

POSTAL®

# KOSZYKI

baskets / корзины / Zwirbeln



□	6x6
H	70
L	70
N°	<b>12.010</b>



□	12x12
H	130
L	60
N°	<b>12.080</b>



□	14x14
H	130
L	65
N°	<b>12.081</b>



□	16x16
H	145
L	65
N°	<b>12.082</b>



□	20x20
H	165
L	100
N°	<b>12.083</b>



□	24x24
H	180
L	95
N°	<b>12.084</b>



□	12x12
H	130
L	65
N°	<b>12.111</b>



□	12x12
H	150
L	70
N°	<b>12.112</b>



□	12x12
H	190
L	50
N°	<b>12.113</b>

# KOSZYKI

baskets / корзины / Zwirbeln



21



□	15x15	18x18	24x24
H	150	190	190
L	75	120	120
N°	<b>12.115</b>	<b>12.118</b>	<b>12.124</b>



□	16x16	16x16	12x12	12x12
H	160	210	200	330
L	85	85	50	63
N°	<b>12.130</b>	<b>12.131</b>	<b>12.148</b>	<b>12.150</b>





# ROZETY

rosettes  
розетки  
Rosetten



13.000 - 13.323

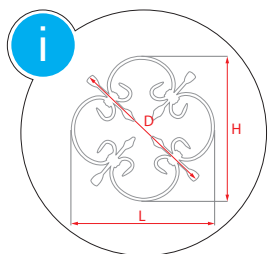

POSTAL®

## ROZETY

rosettes / розетки / Rosetten

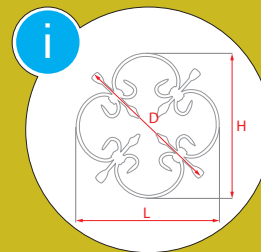

□	12x6	8x8	20x4
H	235	250	250
L	235	250	250
D	280	245	305
N°	<b>13.000</b>	<b>13.003</b>	<b>13.005</b>



□	12x12	12x12
H	375	320
L	300	250
N°	<b>13.006</b>	<b>13.006.01</b>



□	10x5	12x6
H	250	295
L	250	295
D	260	330
N°	<b>13.007</b>	<b>13.008</b>

# ROZETY

rosettes / розетки / Rosetten

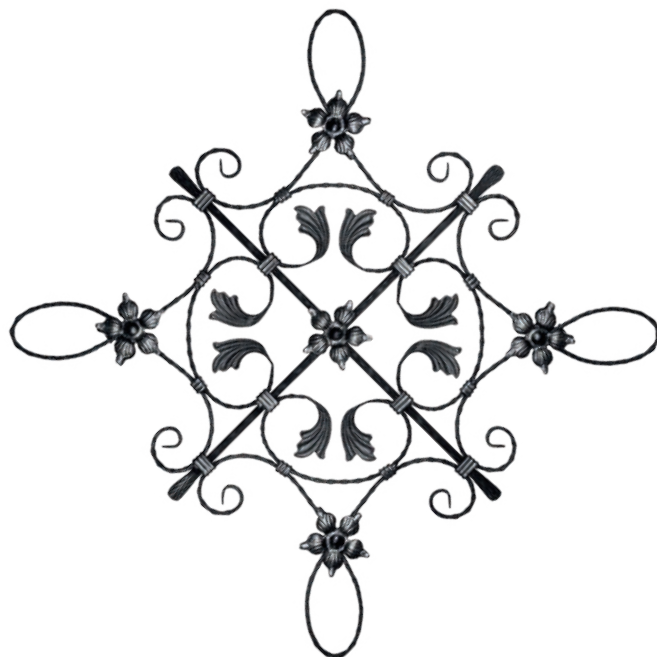

□	12x6	12x6
H	485	880
L	485	880
D	355	640
N°	<b>13.009</b>	<b>13.010</b>

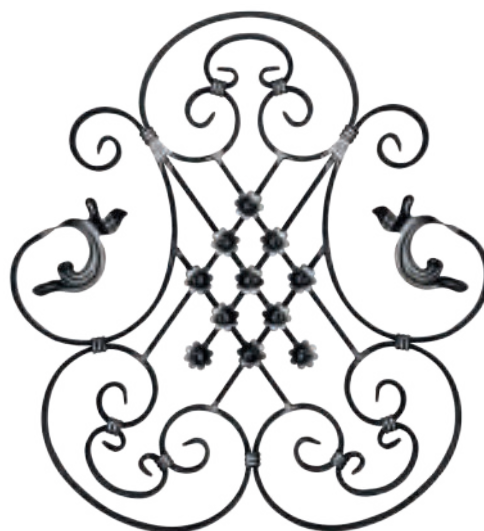
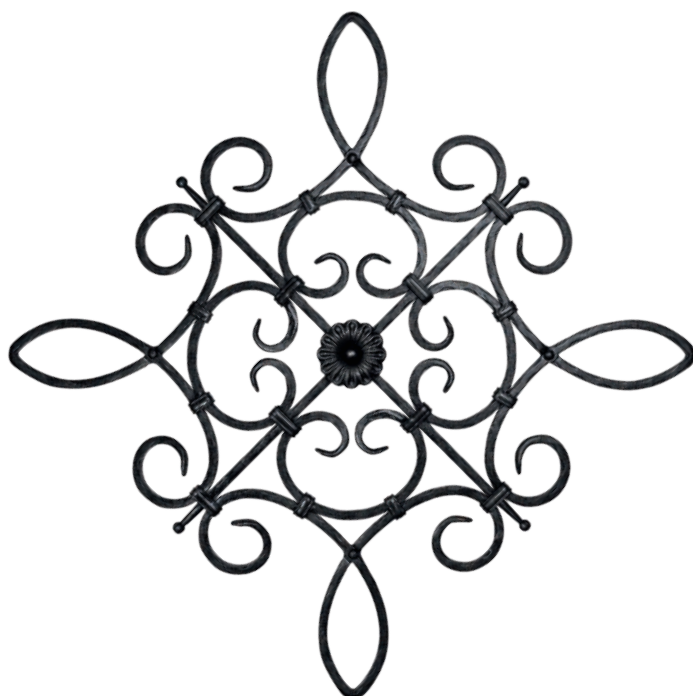

□	12x12	16x8
H	900	700
L	900	650
D	630	
N°	<b>13.011</b>	<b>13.012</b>

# ROZETY

rosettes / розетки / Rosetten

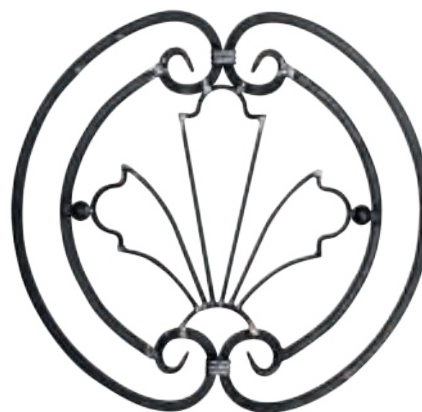
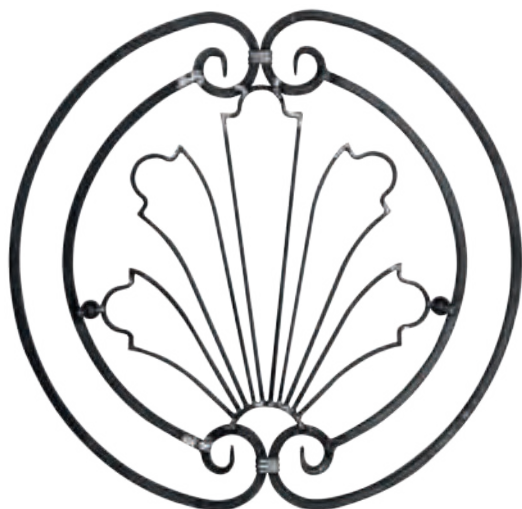
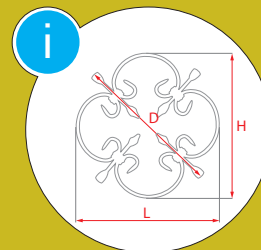

□	14x14
H	680
L	700
N°	<b>13.013</b>

□	14x14
H	540
L	520
N°	<b>13.013.01</b>



□	16x8
H	800
L	450
N°	<b>13.015</b>

□	16x8
H	480
L	410
N°	<b>13.016</b>

□	16x8
H	800
L	440
N°	<b>13.017</b>

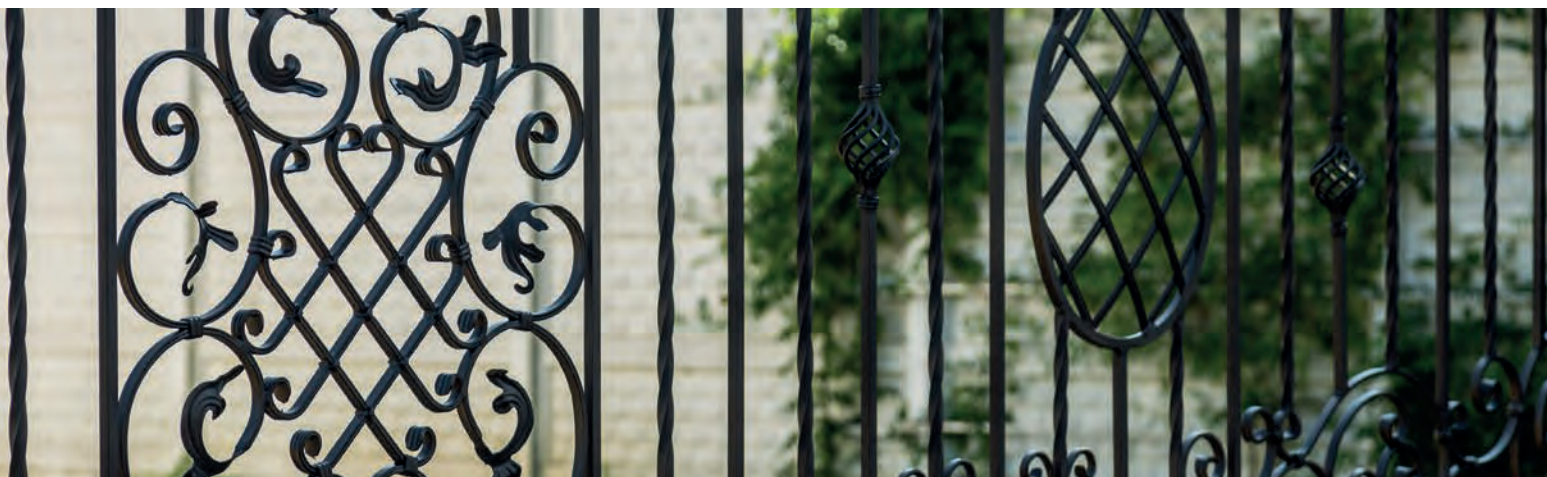

# ROZETY

rosettes / розетки / Rosetten



□	12x12	∅13	10x10
H	530	530	530
L	420	420	420
N°	<b>13.018</b>	<b>13.018.01</b>	<b>13.018.02</b>

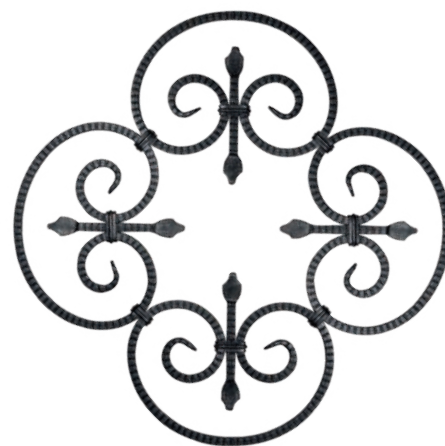
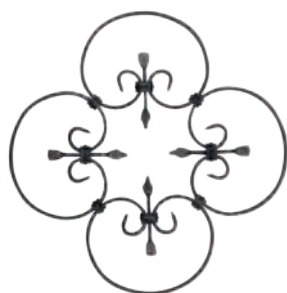

□	10x5	16x8	12x12
H	380	580	590
L	380	400	590
D	325		500
N°	<b>13.020</b>	<b>13.023</b>	<b>13.025</b>



# ROZETY

rosettes / розетки / Rosetten

i

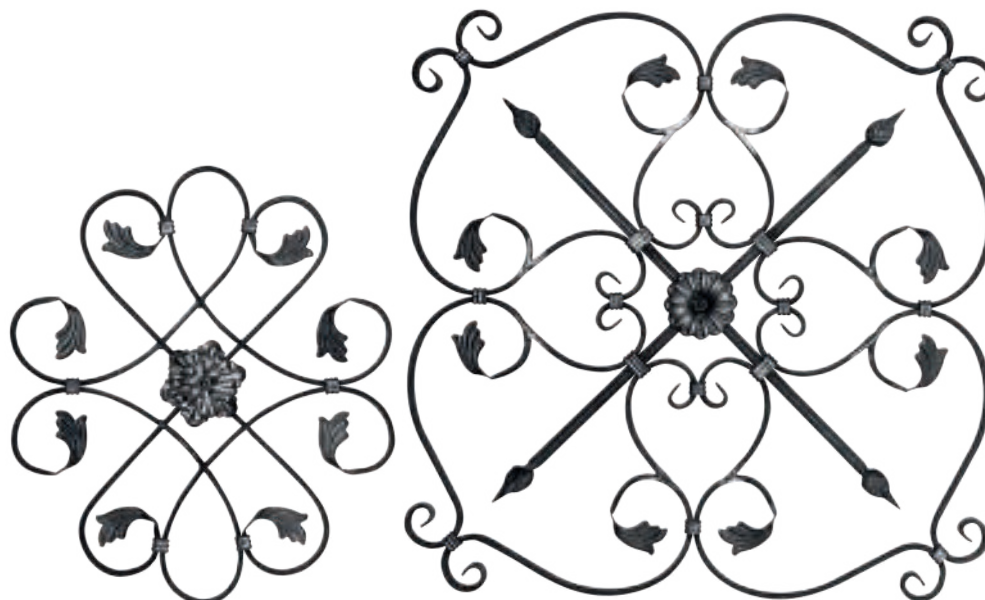
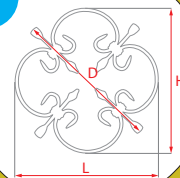

□	16x8	16x8
H	590	800
L	510	800
D		1025
N°	<b>13.026</b>	<b>13.028</b>

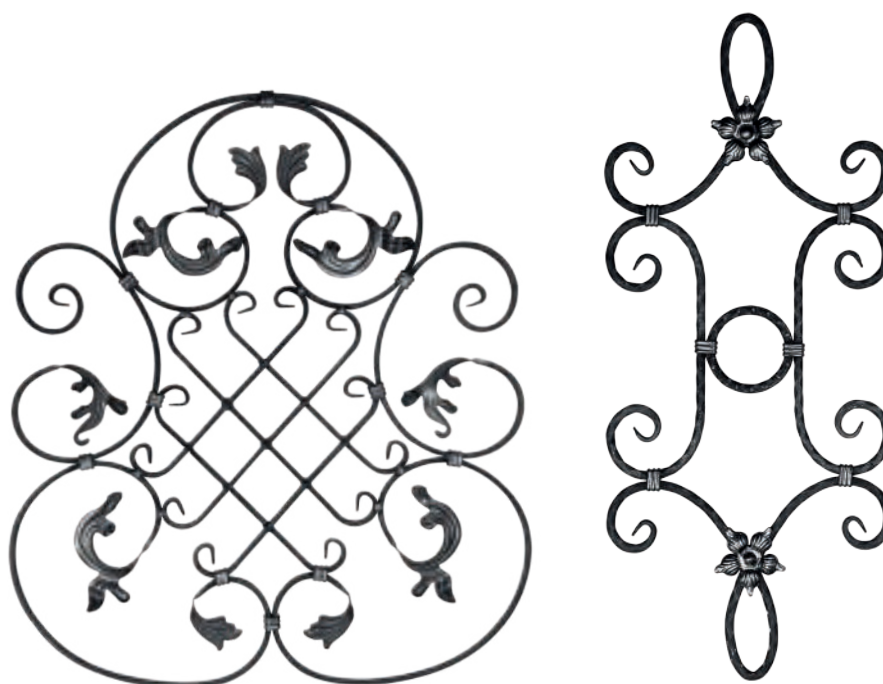

□	16x8	12x12
H	800	900
L	700	385
N°	<b>13.029</b>	<b>13.030</b>

# ROZETY

rosettes / розетки / Rosetten



□	12x12	12x12	12x12
H	560	600	510
L	400	370	690
N°	<b>13.032</b>	<b>13.033</b>	<b>13.034</b>



□	12x12	12x12
H	480	450
L	320	340
N°	<b>13.035</b>	<b>13.037</b>



□	12x12	12x12	12x12
H	500	400	400
L	250	350	300
N°	<b>13.038</b>	<b>13.040</b>	<b>13.041</b>

# ROZETY

rosettes / розетки / Rosetten

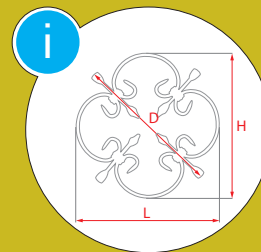

□	16x8	16x8	16x8
H	370	800	800
L	880	300	300
N°	<b>13.042</b>	<b>13.045</b>	<b>13.046</b>



□	16x8	16x8	16x8
H	530	780	800
L	300	780	270
D		870	
N°	<b>13.048</b>	<b>13.056</b>	<b>13.057</b>

# ROZETY

rosettes / розетки / Rosetten

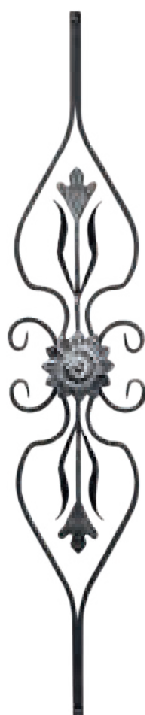

□	16x8	16x8	9,5x5	11,5x5,5
H	950	950	410	410
L	190	180	165	165
N°	<b>13.058</b>	<b>13.059</b>	<b>13.060</b>	<b>13.061</b>



□	12x6	12x6
H	230	250
L	700	700
N°	<b>13.067</b>	<b>13.068</b>

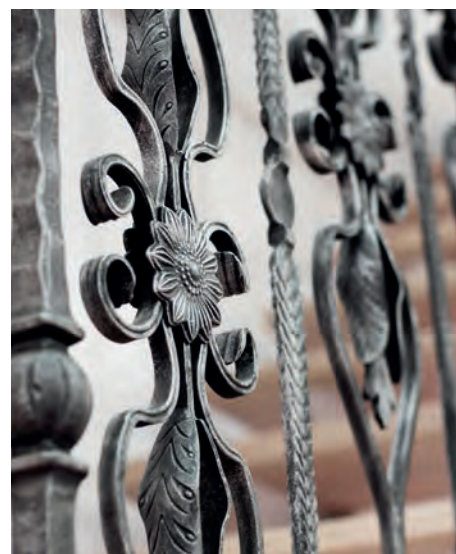

## ROZETY

rosettes / розетки / Rosetten

□	12x6
H	250
L	1200
N°	<b>13.070</b>



□	16x8
H	400
L	1510
N°	<b>13.071</b>



□	16x8
H	400
L	1510
N°	<b>13.072</b>



□	16x8
H	330
L	1270
N°	<b>13.073</b>



□	16x8
H	330
L	1270
N°	<b>13.074</b>



# ROZETY

rosettes / розетки / Rosetten



□	16x8
H	170
L	970
N°	<b>13.090</b>



□	16x8
H	135
L	950
N°	<b>13.091</b>



□	∅12
H	170
L	970
N°	<b>13.092</b>



≠	4
H	100
L	1160
N°	<b>13.093</b>



≠	4
H	100
L	1160
N°	<b>13.094</b>



≠	4
H	90
L	1195
N°	<b>13.096</b>



≠	4
H	120
L	1183
N°	<b>13.097</b>



# ROZETY

rosettes / розетки / Rosetten



□	ø11	ø11
H	950	950
L	500	500
N°	<b>13.081</b>	<b>13.082</b>



□	ø12	ø12
H	1080	1080
L	750	750
N°	<b>13.100</b>	<b>13.101</b>

# ROZETY

rosettes / розетки / Rosetten



□	ø12	ø12
H	880	880
L	750	750
N°	<b>13.104</b>	<b>13.105</b>



□	ø12	ø12
H	880	880
L	500	500
N°	<b>13.106</b>	<b>13.107</b>

# ROZETY

rosettes / розетки / Rosetten



□	16x8	16x8	16x8
H	800	800	740
L	300	300	320
N°	<b>13.111</b>	<b>13.112</b>	<b>13.113</b>



□	16x8	16x8
H	610	400
L	700	800
N°	<b>13.190</b>	<b>13.191</b>

# ROZETY

rosettes / розетки / Rosetten

37



□	16x8
H	400
L	1000
N°	<b>13.192</b>



□	16x8
H	600
L	1580
N°	<b>13.198</b>



## ROZETY

rosettes / розетки / Rosetten



□	ø16, ø14, ø12
H	800
L	1900
N°	<b>13.200</b>



□	ø14	ø14	ø14
H	800	1000	800
L	160	215	165
N°	<b>13.202</b>	<b>13.203</b>	<b>13.204</b>

# ROZETY

rosettes / розетки / Rosetten



39



□	ø12	ø12	ø12	ø12
H	860	860	430	430
L	950	950	190	190
N°	<b>13.209</b>	<b>13.210</b>	<b>50.175</b>	<b>50.176</b>



# ROZETY

rosettes / розетки / Rosetten



□	12x12	12x12	12x12
H	560	490	430
L	400	ø385	ø250
N°	<b>13.241</b>	<b>13.248</b>	<b>13.249</b>



□	12x12	12x12	12x12	12x12
H	ø384	525	415	545
L		ø250	ø385	ø385
N°	<b>13.250</b>	<b>13.251</b>	<b>13.252</b>	<b>13.253</b>



□	12x12	12x12	12x12
H	440	450	500
L	285	380	384
N°	<b>13.256</b>	<b>13.315</b>	<b>13.323</b>

# ROZETY

rosettes / розетки / Rosetten





# TRALKI I SŁUPY

balusters and baluster posts  
блясины  
Stäbe und Brüstungsposten

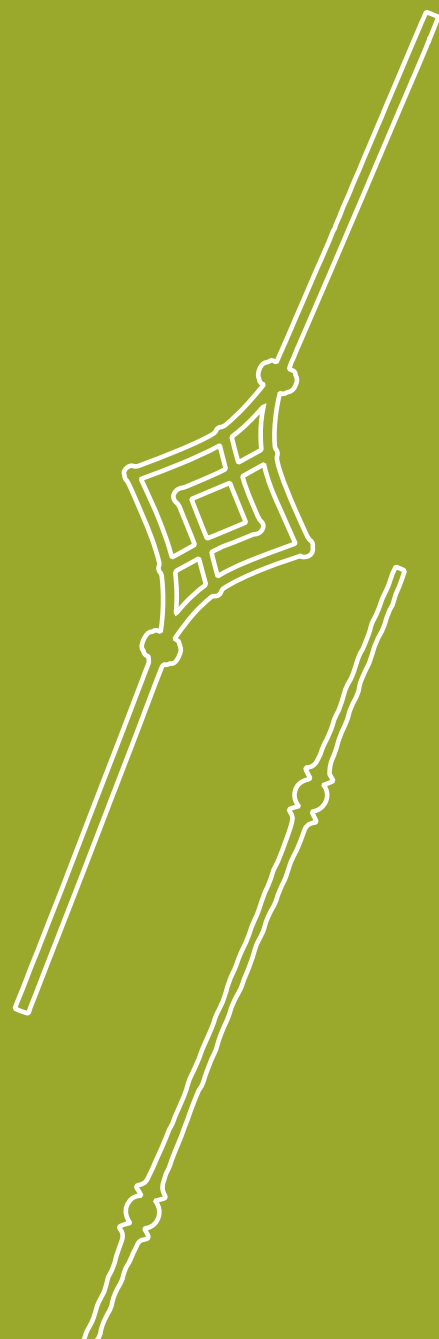

20.001 - 24.266

POSTAL®

# TRALKI | SŁUPY

balusters and baluster posts / балясины / Stäbe und Brüstungspfosten



□	12x12
L	160
H	950
N°	<b>20.001</b>



□	12x12
L	175
H	950
N°	<b>20.003</b>



□	12x12
L	200
H	950
N°	<b>20.010</b>



□	12x12
L	200
H	950
N°	<b>20.010.01</b>



□	12x12
L	200
H	950
N°	<b>20.011</b>



□	14x14
L	200
H	950
N°	<b>20.012</b>



□	14x14
L	200
H	950
N°	<b>20.013</b>



□	12x12
L	190
H	950
N°	<b>20.020</b>

# TRALKI I SŁUPY

balusters and baluster posts / балясины / Stäbe und Brüstungspfosten



□	12x12	12x12	12x12	30x5
L	200	230	230	170
H	950	950	950	800
N°	<b>20.100</b>	<b>20.102</b>	<b>20.105</b>	<b>20.130</b>



□	50x10	16x16	12x12	12x12
L	185	225	950	950
H	850	950	950	950
N°	<b>20.148</b>	<b>20.149</b>	<b>21.010</b>	<b>21.011</b>



□	12x12	12x12	12x6	12x12
L	950	950	350	90
H	950	950	860	950
N°	<b>21.024</b>	<b>21.025</b>	<b>21.116</b>	<b>21.117</b>





□	16x8
L	155
H	950
N°	<b>21.118</b>

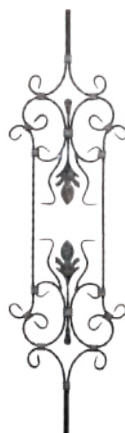

□	12x12
L	270
H	950
N°	<b>21.119</b>



□	12x12
L	170
H	950
N°	<b>21.120</b>



□	16x8
L	165
H	950
N°	<b>21.122</b>



□	12x12
L	240
H	950
N°	<b>21.124</b>



□	12x12
L	200
H	950
N°	<b>21.140</b>



□	12x12
L	275
H	950
N°	<b>21.141</b>



□	12x12
L	195
H	950
N°	<b>21.145</b>



□	12x12
L	200
H	950
N°	<b>21.147</b>

# TRALKI I SŁUPY

balusters and baluster posts / балясины / Stäbe und Brüstungspfosten



□	∅30x1,5	∅30x1,5	∅30x1,5
H	900	900	900
N°	<b>21.900</b>	<b>21.901</b>	<b>21.902</b>



□	∅14	∅14	12x12	12x12
L	36	36	30	30
H	950	950	950	950
N°	<b>22.001</b>	<b>22.002</b>	<b>22.003</b>	<b>22.004</b>



□	12x12	12x12	12x12	12x12
L	35	30	36	36
H	950	950	950	950
N°	<b>22.005</b>	<b>22.013</b>	<b>22.019</b>	<b>22.020</b>

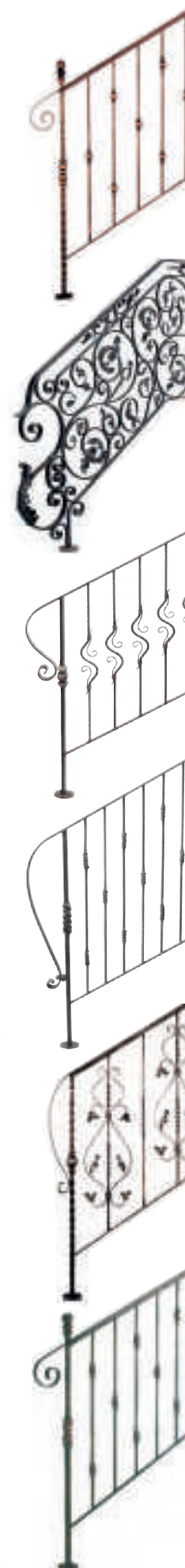

# TRALKI I SŁUPY

balusters and baluster posts / балясины / Stäbe und Brüstungspfosten



□	∅12	∅12	∅12
L	30	24	50
H	950	950	1000
N°	<b>22.021</b>	<b>22.022</b>	<b>22.053</b>



□	12x12	12x12	12x12
L	140	185	180
H	950	950	950
N°	<b>22.100</b>	<b>22.103</b>	<b>22.104</b>



□	12x12	12x12
L	180	145
H	950	950
N°	<b>22.105</b>	<b>22.107</b>

# TRALKI I SŁUPY

balusters and baluster posts / баясины / Stäbe und Brüstungspfosten

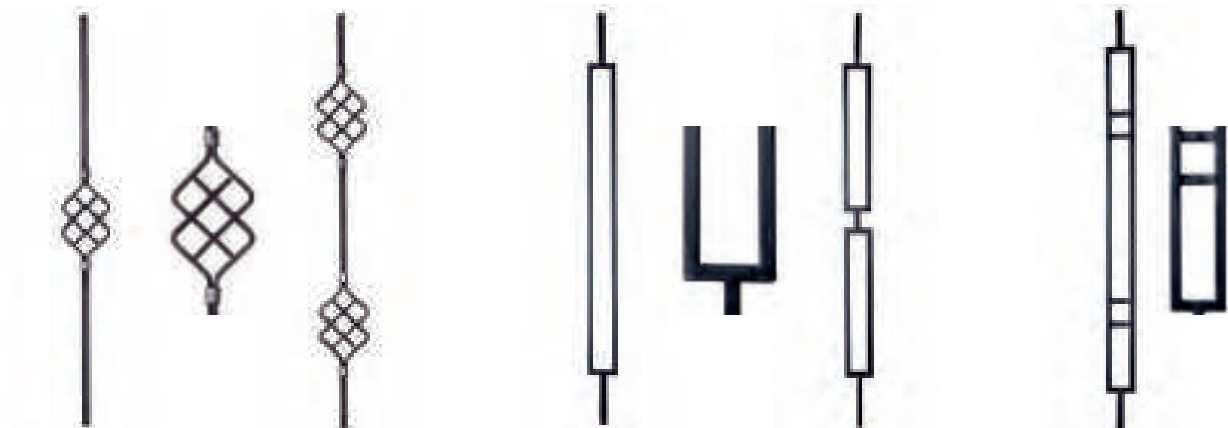

□	12x12	12x12	10x10	10x10	10x10
L	100	100	55	55	55
H	800	800	800	800	800
N°	<b>N 22.150</b>	<b>N 22.151</b>	<b>N 22.200</b>	<b>N 22.201</b>	<b>N 22.203</b>

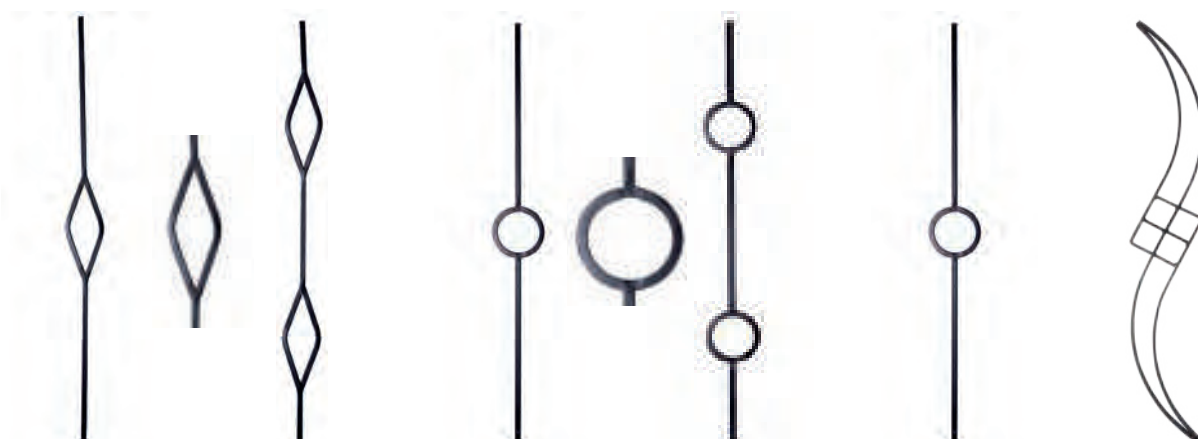

□	10x10	10x10	10x10	10x10	10x10	12x6
L	70	70	100	100	120	120
H	800	800	800	800	800	800
N°	<b>N 22.204</b>	<b>N 22.205</b>	<b>N 22.206</b>	<b>N 22.207</b>	<b>N 22.208</b>	<b>N 22.209</b>

# TRALKI I SŁUPY

balusters and baluster posts / балясины / Stäbe und Brüstungspfosten



□	∅12	∅12	14x14	14x14
L	25	25	30	30
H	950	950	950	950
N°	<b>23.001</b>	<b>23.002</b>	<b>23.003</b>	<b>23.004</b>



□	∅12	∅12	12x12	12x12
L	25	25	30	30
H	950	950	950	950
N°	<b>23.005</b>	<b>23.006</b>	<b>23.007</b>	<b>23.008</b>

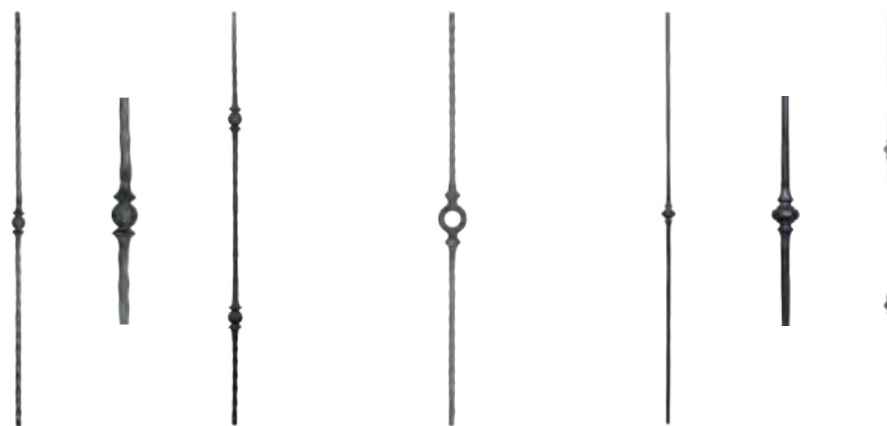

□	14x14	14x14	14x14	∅12	∅12
L	35	35	65	40	40
H	950	950	950	950	950
N°	<b>23.009</b>	<b>23.010</b>	<b>23.015</b>	<b>23.020</b>	<b>23.021</b>



# TRALKI | SŁUPY

balusters and baluster posts / балясины / Stäbe und Brüstungspfosten

51



□	14x14	14x14	16x16
L	35	40	60
H	950	950	950
N°	<b>23.024</b>	<b>23.025</b>	<b>23.065</b>

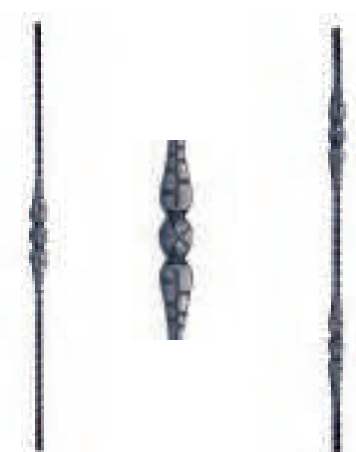

□	12x12	12x12
L	200	200
H	800	800
N°	<b>N 23.030</b>	<b>N 23.031</b>



# TRALKI I SŁUPY

balusters and baluster posts / балясины / Stäbe und Brüstungspfosten



□	20x20	∅25	∅28	25x25	25x25
L	80	55	60	100	50
H	1 200	1 200	1 200	1 200	1 200
N°	<b>24.011</b>	<b>24.111</b>	<b>24.112</b>	<b>24.151</b>	<b>24.254</b>



□	25x25	25x25	25x25	25x25
L	34	48	50	66
H	1 200	1 200	1 200	1 200
N°	<b>24.255</b>	<b>24.257</b>	<b>24.259</b>	<b>24.266</b>



# TRALKI I SŁUPY

balusters and baluster posts / балясины / Stäbe und Brüstungspfosten





# PŁASKOWNIKI I TAŚMY

flat bars and banding materials  
полосы и ленты  
Stangenmaterial und Hespeneisen

30.001 - 31.404

POSTAL®

# PŁASKOWNIKI I TAŚMY

flat bars and banding materials / полосы и ленты /  
Flacheisen und Hespeneisen

**i**



**PRODUKT NA ZAMÓWIENIE**  
for special order /  
продукт на заказ /  
Produkt auf Bestellung



H	100		180			
L	3000	6000	350	680	300	400
□	40x12	40x12	40x12			40x12
N°	<b>30.001</b>	<b>30.001.00</b>	<b>30.001.01</b>			<b>30.001.04</b>
□	50x14	50x14	50x14	50x14	50x14	
N°	<b>30.002</b>	<b>30.002.00</b>	<b>30.002.01</b>	<b>30.002.02</b>	<b>30.002.03</b>	
□	40x10	40x10	40x10	40x10	40x10	40x10
N°	<b>30.003</b>	<b>30.003.00</b>	<b>30.003.01</b>	<b>30.003.02</b>	<b>30.003.03</b>	<b>30.003.04</b>



# PŁASKOWNIKI I TAŚMY

flat bars and banding materials / полосы и ленты / Flacheisen und Hespeneisen

57

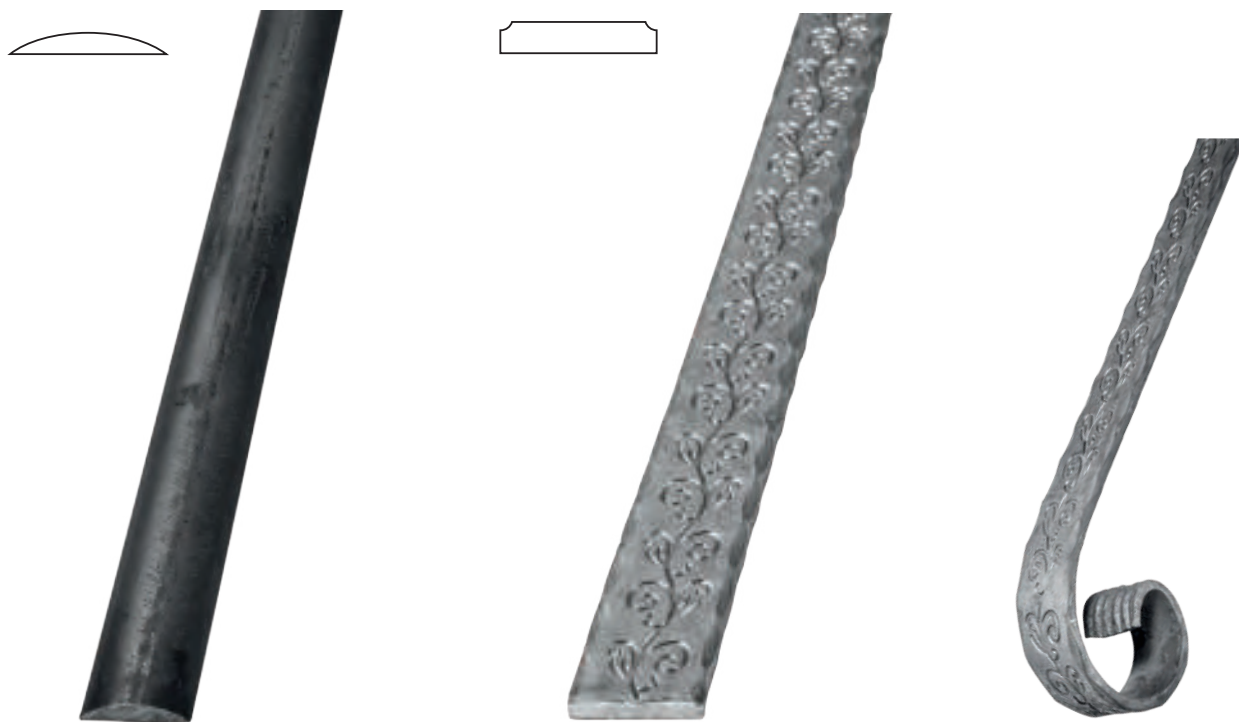

H					100
L	3000	6000	3000	350	
□	40x8	40x8	40x8	40x8	
N°	<b>30.008</b>	<b>30.008.00</b>	<b>30.010</b>	<b>30.010.01</b>	



L	3000	3000	6000	3000	6000
□	20x5	25x5	25x5	30x5	30x5
N°	<b>30.100</b>	<b>30.101</b>	<b>30.101.00</b> ☒	<b>30.102</b>	<b>30.102.00</b> ☒

# PŁASKOWNIKI I TAŚMY

flat bars and banding materials / полосы и ленты /  
Stangenmaterial und Hespenseisen



**PRODUKT NA ZAMÓWIENIE**  
for special order /  
продукт на заказ /  
Produkt auf Bestellung



H				100
L	3000	6000	350	680
□	40x8		40x8	
N°	<b>30.103</b>		<b>30.103.01</b>	
□	40x5	40x5	40x5	40x5
N°	<b>30.105</b>	<b>30.105.00</b>	<b>30.105.01</b>	<b>30.105.02</b>

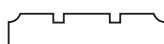

H				100
L	3000	350	400	
□	40x5	40x5	40x5	
N°	<b>30.113</b>	<b>30.113.01</b>	<b>30.113.04</b>	
□	40x8			
N°	<b>30.123</b>			

# PŁASKOWNIKI I TAŚMY

flat bars and banding materials / полосы и ленты / Stangenmaterial und Hespeneisen

59



H			100		100
L	3000	6000	350	3000	400
□	40x5	40x5	40x5	40x5	40x5
N°	<b>30.111</b>	<b>30.111.00</b> ☒	<b>30.111.01</b>	<b>30.114</b>	<b>30.114.01</b>



# PŁASKOWNIKI I TAŚMY

flat bars and banding materials / полосы и ленты /  
Stangenmaterial und Hespeneisen



**PRODUKT NA ZAMÓWIENIE**  
for special order /  
продукт на заказ /  
Produkt auf Bestellung



L	3000
□	40x5
N°	<b>30.115</b>
□	40x8
N°	<b>30.125</b> ☒



L	3000	3000
□	12x6	20x10
N°	<b>30.200</b>	<b>30.202</b>

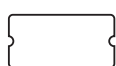

L	3000
□	16x8
N°	<b>30.220</b>

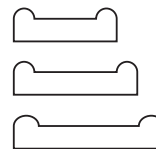

L	3000	6000
□	25x8	25x8
N°	<b>31.101</b>	<b>31.101.00</b>
□	30x8	30x8
N°	<b>31.102</b>	<b>31.102.00</b>
□	40x8	40x8
N°	<b>31.103</b>	<b>31.103.00</b>

# PŁASKOWNIKI I TAŚMY

flat bars and banding materials / полосы и ленты / Stangenmaterial und Hespeneisen

61

miękkie

soft and flexible / мягкий и гибкий / weich und flexibel



L	3000	2000	3000	3000	3000	3000
□	14x4	18x1,5	14x3	20x4	14x4	14x4
N°	<b>31.300.01</b>	<b>31.350</b>	<b>31.400</b>	<b>31.402</b>	<b>31.403</b>	<b>31.404</b>

L	1000	1000	1000	1000	1000	1000
□	14x4	18x1,5	14x3	20x4	14x4	14x4
N°	<b>N 31.300.01M1</b>	<b>N 31.350M1</b>	<b>N 31.400M1</b>	<b>N 31.402M1</b>	<b>N 31.403M1</b>	<b>N 31.404M1</b>

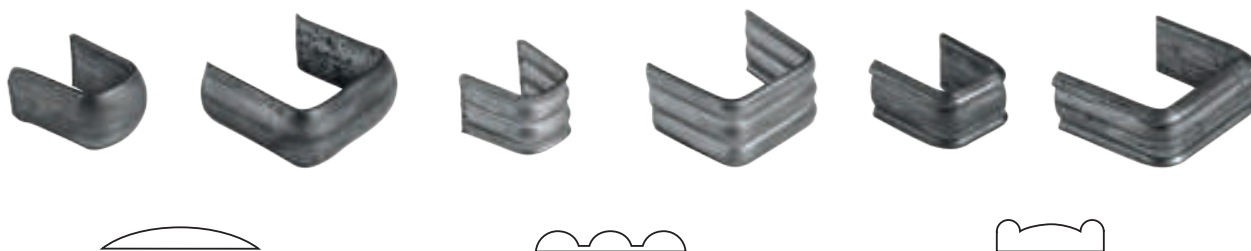

≠	14x4	14x4	18x1,5	18x1,5	14x3	14x3
□	12x12	24x12	12x12	24x12	12x12	24x12
N°	<b>N 31.300.12</b>	<b>N 31.300.24</b>	<b>N 31.350.12</b>	<b>N 31.350.24</b>	<b>N 31.400.12</b>	<b>N 31.400.24</b>

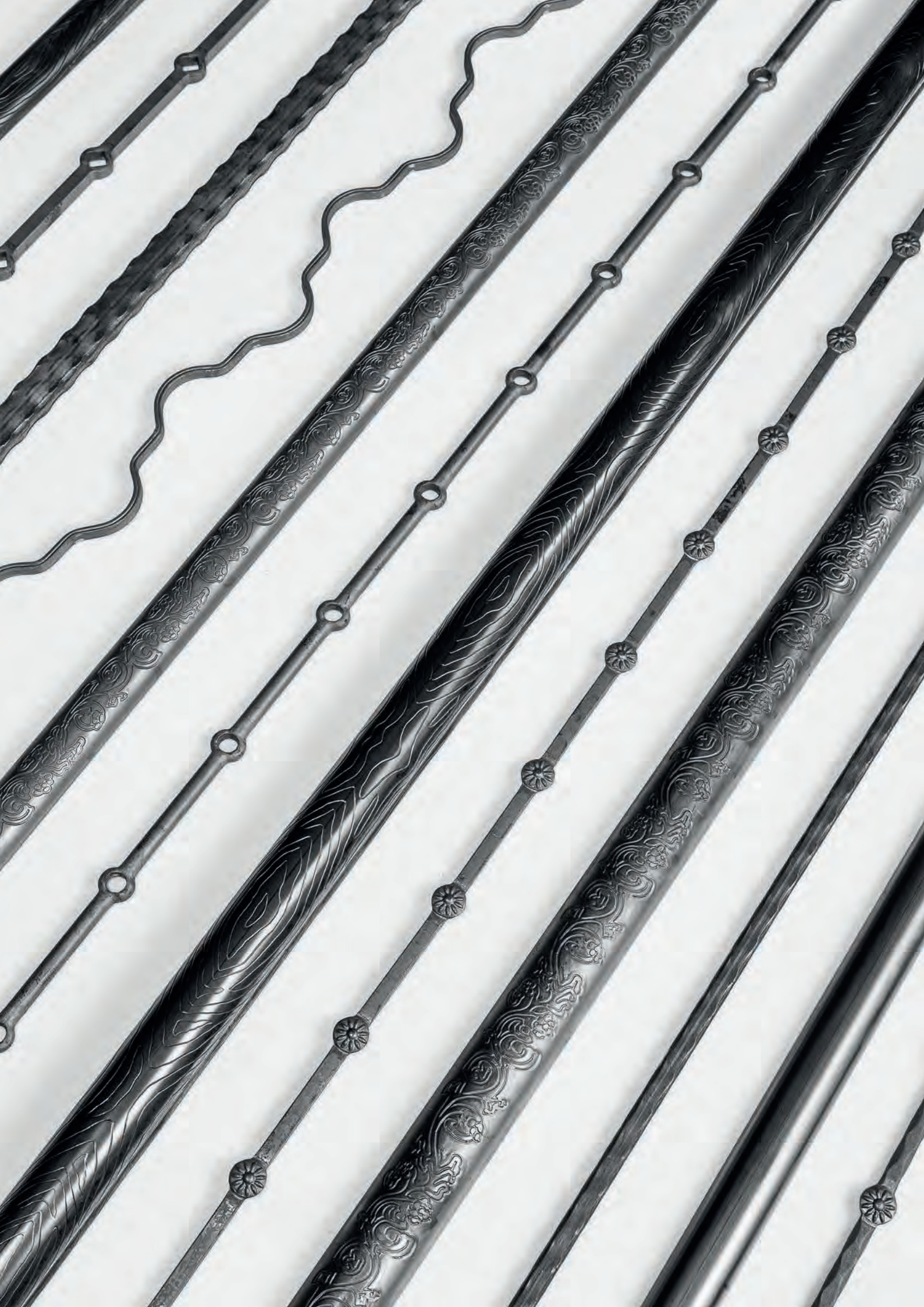

# PROFILE ZAMKNIĘTE I PRĘTY OZDOBNE

bars and decorative bars  
прутья и декоративные прутья  
Vierkantrohre und decorative Stäbe



30.020 - 34.231

POSTAL®

# PROFILE ZAMKNIĘTE I PRĘTY OZDOBNE

bars and decorative bars / прутья и декоративные прутья /  
Vierkantrohre und decorative Stäbe

64

**i**



**PRODUKT NA ZAMÓWIENIE**  
for special order /  
продукт на заказ /  
Produkt auf Bestellung



□	48x20	48x20	48x20	62x30	62x30	60x32
≠	1,5	1,5	1,5	1,5	1,5	1,5
L	3000	3000	3000	3000	3000	3000
N°	<b>30.020</b>	<b>30.020.01</b>	<b>30.020.02</b>	<b>30.021</b>	<b>30.021.01</b>	<b>30.021.02</b>



□	54x54	54x54	54x54	□	48x20	62x30	54x54
≠	1,5	1,5	1,5	H	40	50	36
L	3000	3000	3000	N°	<b>30.030</b>	<b>30.031</b>	<b>30.032</b>
N°	<b>30.022</b>	<b>30.022.01</b>	<b>30.022.02</b>				

# PROFILE ZAMKNIĘTE I PRĘTY OZDOBNE

bars and decorative bars / прутья и декоративные прутья /  
Vierkantrohre und decorative Stäbe

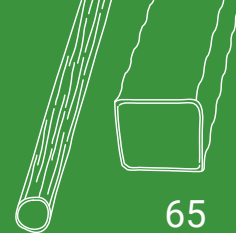

65



□	L	N°
12x12	3000	<b>32.001</b>
12x12	6000	<b>32.001.00</b>
14x14	3000	<b>32.003</b>
14x14	6000	<b>32.003.00</b> ☒
16x16	3000	<b>32.005</b>
16x16	6000	<b>32.005.00</b>
20x20	3000	<b>32.007</b>



□	L	N°
∅10-12	1100	<b>32.100</b>
∅12-16	1100	<b>32.101</b>

# PROFILE ZAMKNIĘTE I PRĘTY OZDOBNE

bars and decorative bars / прутья и декоративные прутья /  
Vierkantrohre und decorative Stäbe

66



□	L	N°
∅8	3000	<b>32.111</b>
∅10	3000	<b>32.112</b>
∅12	3000	<b>32.113</b>
∅14	3000	<b>32.114</b>
∅16	3000	<b>32.115</b>
∅20	3000	<b>32.117</b>



□	L	N°
∅25	2750	<b>32.200</b>
∅30	2750	<b>32.201</b>
∅38	2750	<b>32.202</b>

# PROFILE ZAMKNIĘTE I PRĘTY OZDOBNE

bars and decorative bars / прутья и декоративные прутья /  
Vierkantrohre und decorative Stäbe

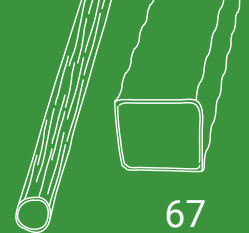

67

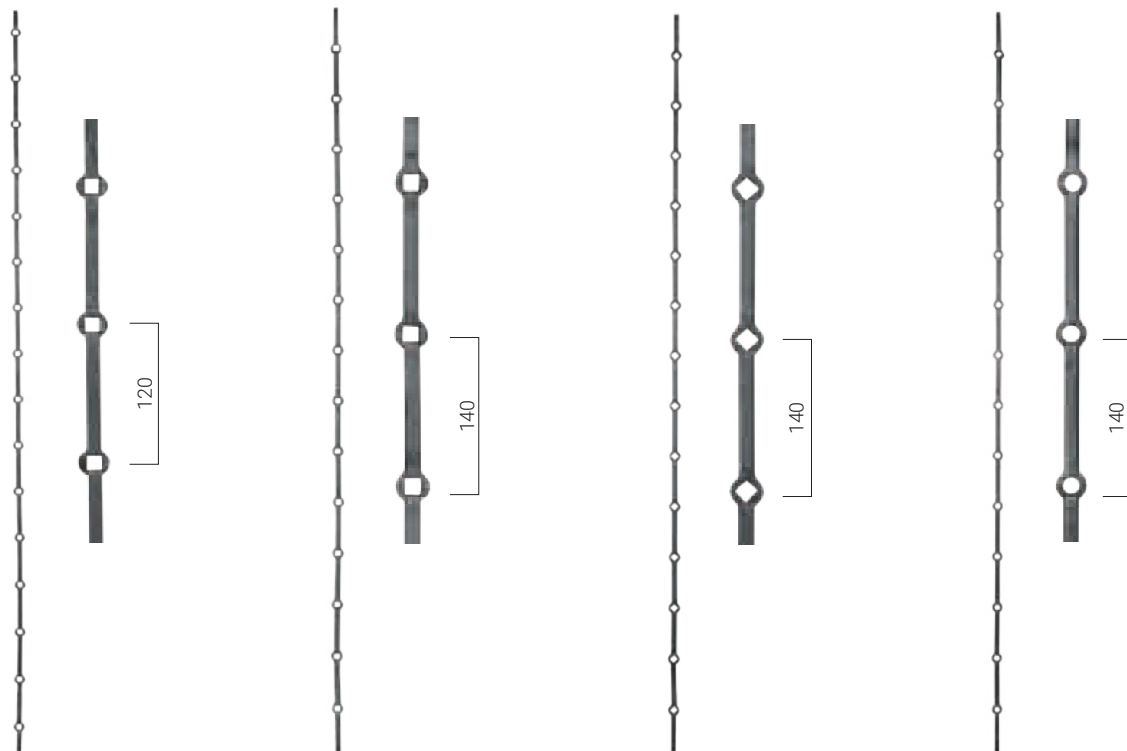

□	12x12	14x14	14x14	∅14
H	2000	2000	2000	2000
N°	<b>33.000</b>	<b>33.001</b>	<b>33.013</b>	<b>33.023</b>

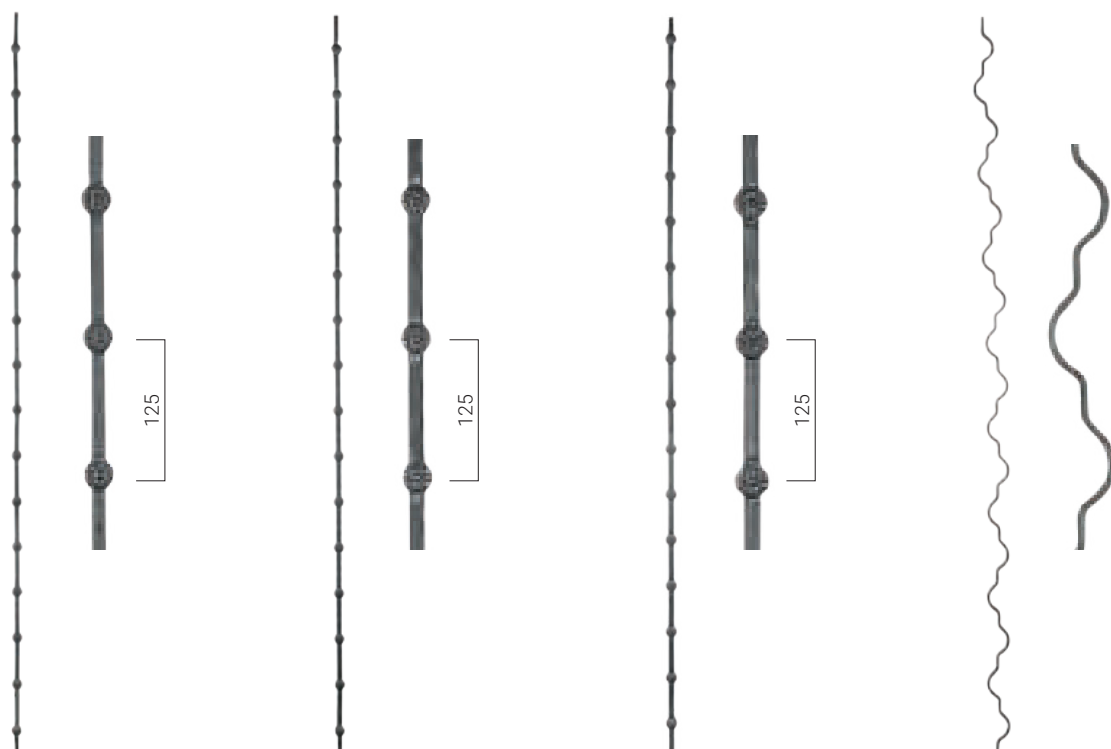

□	12x12	12x12	14x14	12x6
H	2000	2000	2000	2000 x 65
N°	<b>33.098</b>	<b>33.099</b>	<b>33.100</b>	<b>33.201</b>

# PROFILE ZAMKNIĘTE I PRĘTY OZDOBNE

bars and decorative bars / прутья и декоративные прутья /  
Vierkantrohre und decorative Stäbe



**PRODUKT NA ZAMÓWIENIE**  
for special order /  
продукт на заказ /  
Produkt auf Bestellung



□	≠	L	N°
15x15	1,5	3000	<b>34.000</b>
20x20	2	3000	<b>34.002</b>
20x20	2	6000	<b>34.002.00</b> ☒
25x25	2	3000	<b>34.005</b>
30x30	2	3000	<b>34.008</b>
30x30	2	6000	<b>34.008.00</b> ☒
40x40	2	3000	<b>34.011</b>
40x40	2	6000	<b>34.011.00</b> ☒
50x50	3	3000	<b>34.014</b>
60x60	3	3000	<b>34.017</b>
80x80	3	3000	<b>34.020</b>
80x80	3	6000	<b>34.020.00</b> ☒
100x100	3	3000	<b>34.023</b>
100x100	3	6000	<b>34.023.00</b> ☒



# PROFILE ZAMKNIĘTE I PRĘTY OZDOBNE

bars and decorative bars / прутья и декоративные прутья /  
Vierkantrohre und decorative Stäbe

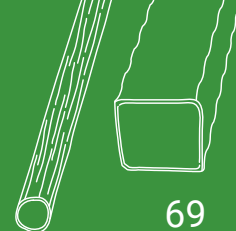

69



□	≠	L	N°
30x20	2	3000	<b>34.102</b>
30x20	2	6000	<b>34.102.00</b> ☒
40x20	2	3000	<b>34.105</b>
40x20	2	6000	<b>34.105.00</b> ☒
40x30	2	3000	<b>34.107</b>
40x30	2	6000	<b>34.107.00</b> ☒
50x30	3	3000	<b>34.111</b>
50x30	3	6000	<b>34.111.00</b> ☒
60x40	3	3000	<b>34.120</b>
60x40	3	6000	<b>34.120.00</b> ☒



□	≠	L	N°
∅32	1,2	3000	<b>34.221</b>
∅40	1,2	3000	<b>34.230</b>
∅51	1,2	3000	<b>34.231</b>



# GROTY

spearheads

ПИКИ

Spitzen



40.001 - 40.300

POSTAL<sup>®</sup>

# GROTY

spearheads / пики / Spitzen



□	∅15	∅16	∅24	∅25	∅30
H	150	150	160	110	125
L	55	66	63	55	65
N°	<b>40.001</b>	<b>40.002</b>	<b>40.003</b>	<b>40.006</b>	<b>40.007</b>



□	∅18	∅12	∅15	∅14	∅24	∅25
H	110	100	125	140	128	140
L	48	45	55	110	65	70
N°	<b>40.008</b>	<b>40.011</b>	<b>40.012</b>	<b>40.013</b>	<b>40.017</b>	<b>40.018</b>



# GROTY

spearheads / пики / Spitzen

73



□	∅13	∅13	∅20	∅16	∅26	∅20
H	125	130	110	76	135	130
L	60	53	60	43	70	70
N°	<b>40.041</b>	<b>40.045</b>	<b>40.048</b>	<b>N 40.048.01</b>	<b>40.049</b>	<b>40.050</b>



□	∅12	∅12	12X12	∅17	∅20	∅25
H	130	130	115	155	80	125
L	60	60	53	70	45	65
N°	<b>40.052</b>	<b>40.052.02</b>	<b>40.052.03</b>	<b>40.053</b>	<b>40.055</b>	<b>40.056</b>



# GROTY

spearheads / пики / Spitzen



□	∅20	∅25	∅20	∅16	∅20	∅26
H	120	135	115	82	115	140
L	55	65	58	40	58	70
N°	<b>40.058</b>	<b>40.059</b>	<b>40.060</b>	<b>40.060.01</b>	<b>40.060.02</b>	<b>40.061</b>



□	12x12	14x14	12x12	14x14
H	120	140	150	180
L	42	47	40	43
N°	<b>40.065</b>	<b>40.066</b>	<b>40.067</b>	<b>40.068</b>



# GROTY

spearheads / пики / Spitzen

75



□	∅25	∅20	∅25	∅20	∅30
H	125	95	135	98	160
L	40	30	40	33	50
N°	<b>40.071</b>	<b>40.071.01</b>	<b>40.072</b>	<b>40.072.01</b>	<b>40.073</b>



□	∅32	∅25	15X15	15X15	12X12
H	125	110	135	130	120
L	60	50	60	50	43
N°	<b>40.077</b>	<b>40.077.02</b>	<b>40.078</b>	<b>40.078.01</b>	<b>40.078.02</b>



□	∅16	∅16	∅25
H	155	160	125
L	65	65	45
N°	<b>40.080</b>	<b>40.081</b>	<b>40.083</b>

# GROTY

spearheads / пики / Spitzen



□	20x20	25x25	20x20	15x15	32x32
H	100	160	125	82	160
L	20	25	30	20	40
N°	<b>40.088.01</b>	<b>40.089</b>	<b>40.092</b>	<b>40.092.01</b>	<b>40.093</b>



□	12x12	∅18	24x24	24x24	∅33	∅30	∅24
H	95	125	60	60	150	120	88
L	27	40	35	30	40	35	28
N°	<b>40.095</b>	<b>40.096</b>	<b>40.097</b>	<b>40.097.30</b>	<b>40.098.01</b>	<b>40.098.02</b>	<b>40.098.03</b>



□	25x25	30x30	40x40	18x21	∅16
H	120	155	200	105	160
L	67	92	117	53	90
N°	<b>40.099.01</b>	<b>40.099.02</b>	<b>40.099.03</b>	<b>40.099.04</b>	<b>40.100</b>

# GROTY

spearheads / пики / Spitzen

77



□	∅13	14x14	∅16	15x15	18x18	26x26
H	140	110	160	145	250	290
L	50	50	65	80	80	75
N°	<b>40.102</b>	<b>40.102.01</b>	<b>40.104</b>	<b>40.106</b>	<b>40.110</b>	<b>40.111</b>



□	∅40	∅16	∅29	∅35	12x12	20x20
H	200	120	180	205	90	135
L	100	73	60	65	63	90
N°	<b>40.112</b>	<b>40.112.01</b>	<b>40.117</b>	<b>40.118</b>	<b>40.123</b>	<b>40.125</b>

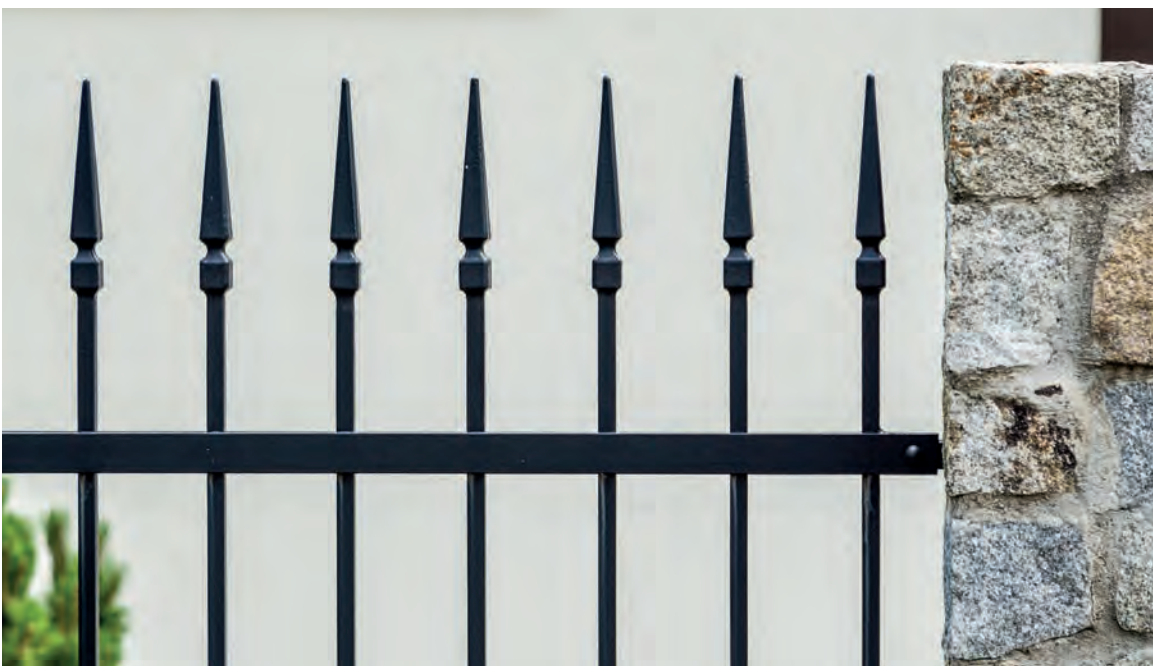

# GROTY

spearheads / пики / Spitzen



□	∅33	12x12	16x16	∅12	12x12
H	130	150	57	92	120
L	47	30	38	35	35
N°	<b>40.126</b>	<b>40.133</b>	<b>40.140</b>	<b>40.150</b>	<b>40.151</b>



□	16x16	16x16	20x20	∅16	∅26	36
H	107	142	148	132	134	145
L	25	28	35	85	64	36
N°	<b>40.153</b>	<b>40.154</b>	<b>40.155</b>	<b>40.156</b>	<b>40.157</b>	<b>40.159</b>



# GROTY

spearheads / пики / Spitzen



79



□	16x16	12x12	16x16	12x12
H	105	200	155	160
L	60		60	50
N°	<b>40.162</b>	<b>40.170</b>	<b>40.182</b>	<b>40.183</b>



□	∅22	8x16	15x15	18x18	
H	80	90	82	110	165
L	22	55	15	18	70
N°	<b>40.200</b>	<b>N 40.202</b>	<b>40.210</b>	<b>40.211</b>	<b>40.300</b>





# PRZEKUWKI

ornamental steel collars

насадки

Zierhülsen

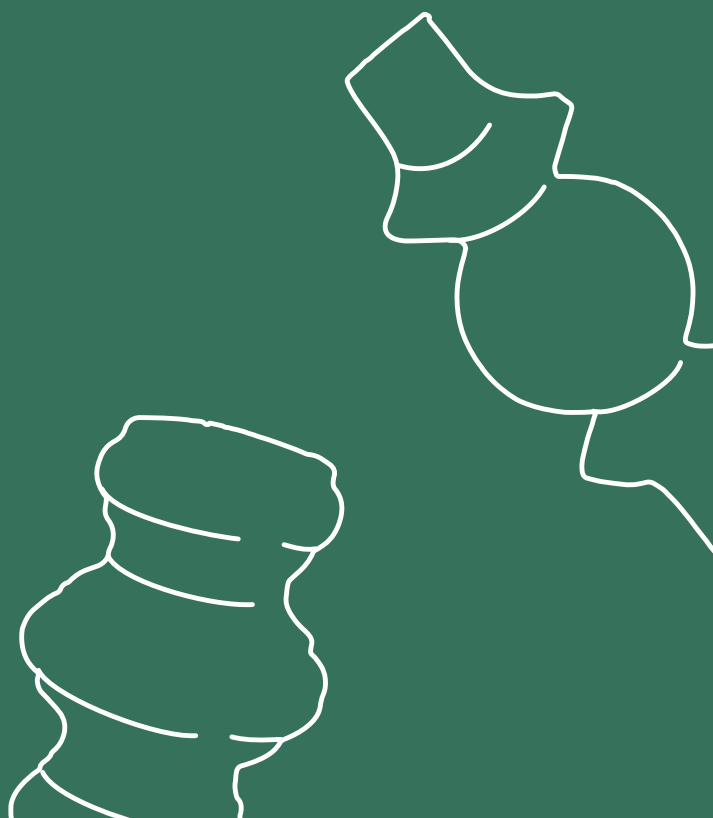

41.001 - 41.506

POSTAL®

# PRZEKUWKI

ornamental steel collars/ насадки / Zierhülsen



□	12,5x12,5	12,5x12,5	
H	39	67	67
L	40	40	40
N°	<b>41.001</b>	<b>41.002</b>	<b>41.002.01</b>



□	14,5x14,5	14,5x14,5	∅14,5	∅14,5
H	44	67	40	67
L	45	45	39	40
N°	<b>41.003</b>	<b>41.004</b>	<b>41.005</b>	<b>41.006</b>



□	16,5x16,5	16,5x16,5	∅16,5	∅16,5
H	44	67	44	67
L	45	45	45	45
N°	<b>41.007</b>	<b>41.008</b>	<b>41.011</b>	<b>41.012</b>

# PRZEKUWKI

ornamental steel collars/ насадки / Zierhülsen

83



□	12,5x12,5	12,5x12,5	14,5x14,5	14,5x14,5	16,5x16,5	16,5x16,5
H	40	65	40	65	40	65
L	38	38	38	38	38	38
N°	<b>41.021</b>	<b>41.022</b>	<b>41.023</b>	<b>41.024</b>	<b>41.025</b>	<b>41.026</b>



□	ø35,5	30,5 x 30,5	27x27
H	80	80	215
L	69	69	63
N°	<b>41.050</b>	<b>41.060</b>	<b>41.070</b>

# PRZEKUWKI

ornamental steel collars/ насадки / Zierhülsen



□	12,5x12,5	14,5x 14,5	16,5x16,5	21,5x21,5	∅13	∅14,5	∅16,5
H	22	22	22	25	25	22	22
L	40	40	40	45	35	40	40
N°	<b>41.102</b>	<b>41.104</b>	<b>41.105</b>	<b>41.106</b>	<b>41.111</b>	<b>41.114</b>	<b>41.115</b>



□	12,5x12,5	14,5x14,5	16,5x16,5	20,5x20,5	25,5x25,5
H	22	22	22	35	35
L	33	38	38	55	55
N°	<b>41.202</b>	<b>41.204</b>	<b>41.205</b>	<b>41.206</b>	<b>41.207</b>

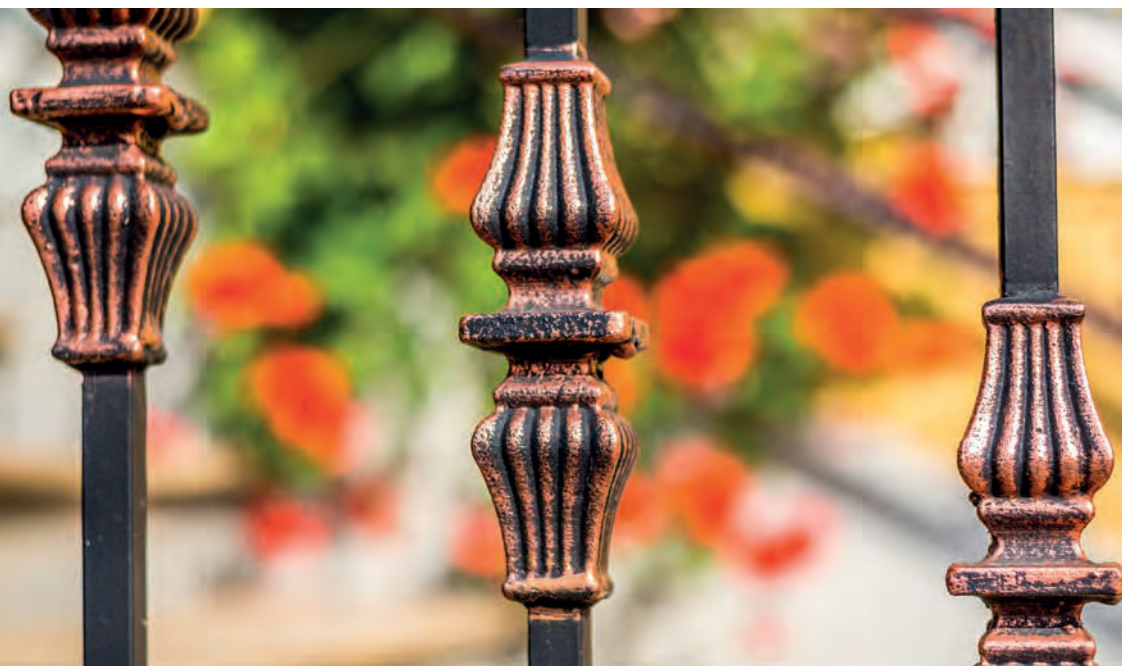

# PRZEKUWKI

ornamental steel collars/ насадки / Zierhülsen



85



□	14,5x14,5	14,5x14,5
H	70	130
L	35	35
N°	<b>41.306</b>	<b>41.307</b>



□	16x16	16x16
H	75	148
L	42	48
N°	<b>41.315</b>	<b>41.316</b>



□	∅16	∅16
H	75	125
L	38	38
N°	<b>41.317</b>	<b>41.318</b>



# PRZEKUWKI

ornamental steel collars/ насадки / Zierhülsen



□	∅12	12x12	12x12
H	140	140	160
L	28	26	25
N°	<b>41.400</b>	<b>41.401</b>	<b>41.402</b>



□	14x14	12 - 14	16 - 20	20 - 30
H	80	70	75	150
L	35	30	35	35
N°	<b>41.403</b>	<b>41.407</b>	<b>41.408</b>	<b>41.409</b>

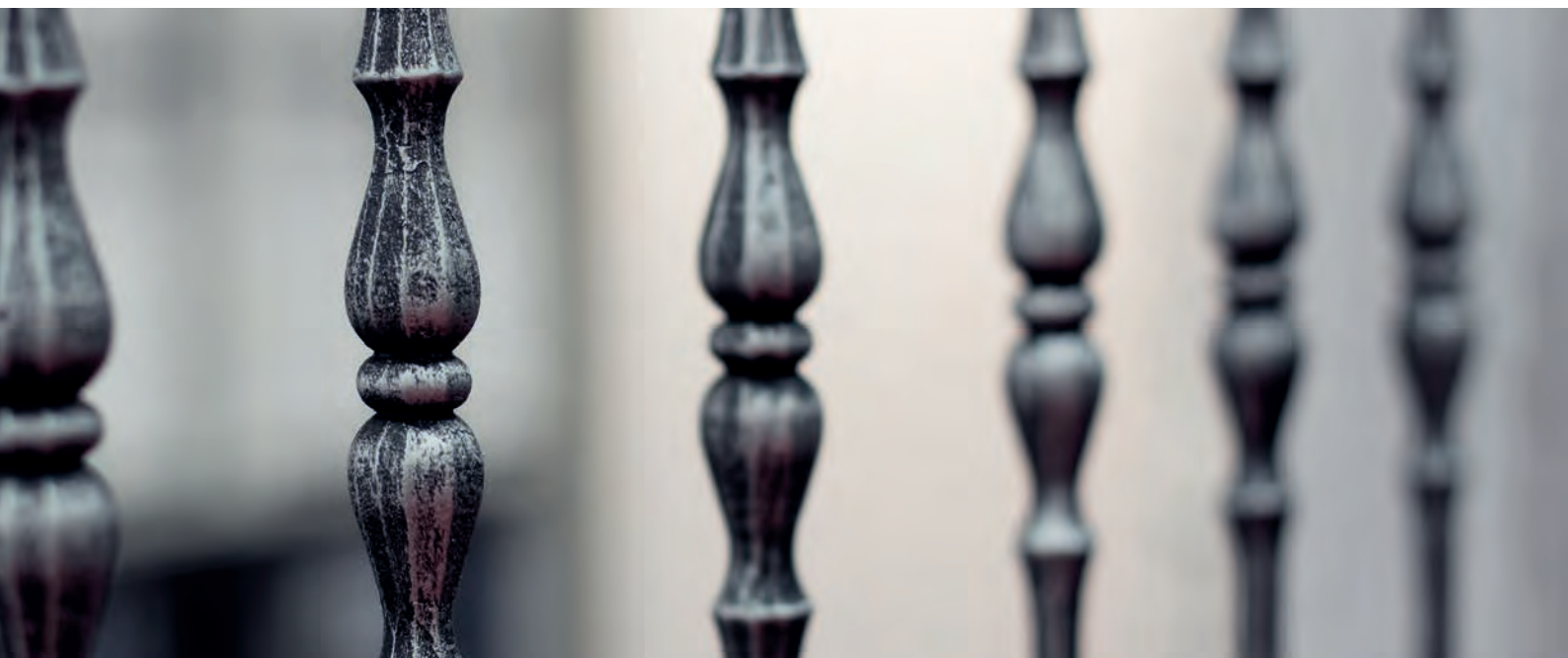

# PRZEKUWKI

ornamental steel collars/ насадки / Zierhülsen

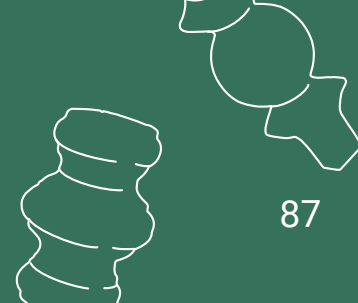

cienkościenne  
thin-walled / тонкостенные / dünnwandig



□	12,5x12,5	12,5x12,5
H	39	67
L	40	40
N°	<b>41.501</b>	<b>41.502</b>

cienkościenne  
thin-walled / тонкостенные / dünnwandig



□	14,5x14,5	14,5x14,5
H	40	67
L	45	45
N°	<b>41.503</b>	<b>41.504</b>

cienkościenne  
thin-walled / тонкостенные / dünnwandig



□	∅14,5	∅14,5
H	39	67
L	40	40
N°	<b>41.505</b>	<b>41.506</b>

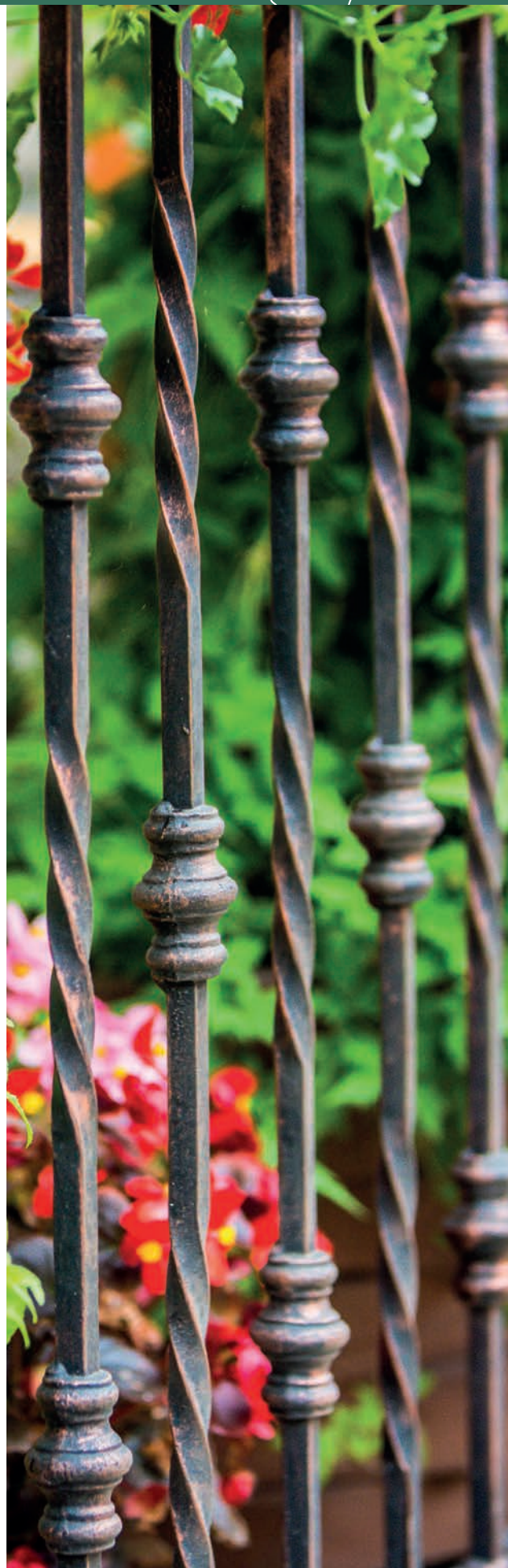



# GAŁKI I KULE

knobs and spheres  
верхушки и шары  
Pfostenaufsätze und Kugeln



42.000 - 43.800.01

POSTAL<sup>®</sup>

## GAŁKI I KULE

knobs and spheres / верхушки и шары / Pfostenaufsätze und Kugeln



□	ø28
H	80
N°	<b>42.000</b>



□	ø40
H	90
N°	<b>42.001</b>



□	ø50
H	90
N°	<b>42.003</b>



□	25x25
H	60
N°	<b>42.004</b>



□	40x40
H	85
N°	<b>42.005</b>



□	60x60
H	125
N°	<b>42.005.01</b>



□	ø27
H	60
N°	<b>42.006</b>



□	ø42
H	85
N°	<b>42.007</b>



□	ø48
H	125
N°	<b>42.008</b>

# GĄŁKI I KULE

knobs and spheres / верхушки и шары / Pfostenaufsätze und Kugeln



91



□	ø30	ø45	ø55	
H	42	50	70	200x220
N°	<b>42.011</b>	<b>42.012</b>	<b>42.013</b>	<b>42.030</b>



## GAŁKI I KULE

knobs and spheres / верхушки и шары / Pfostenaufsätze und Kugeln

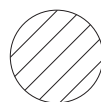
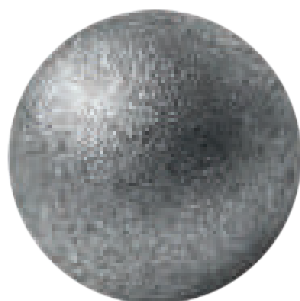
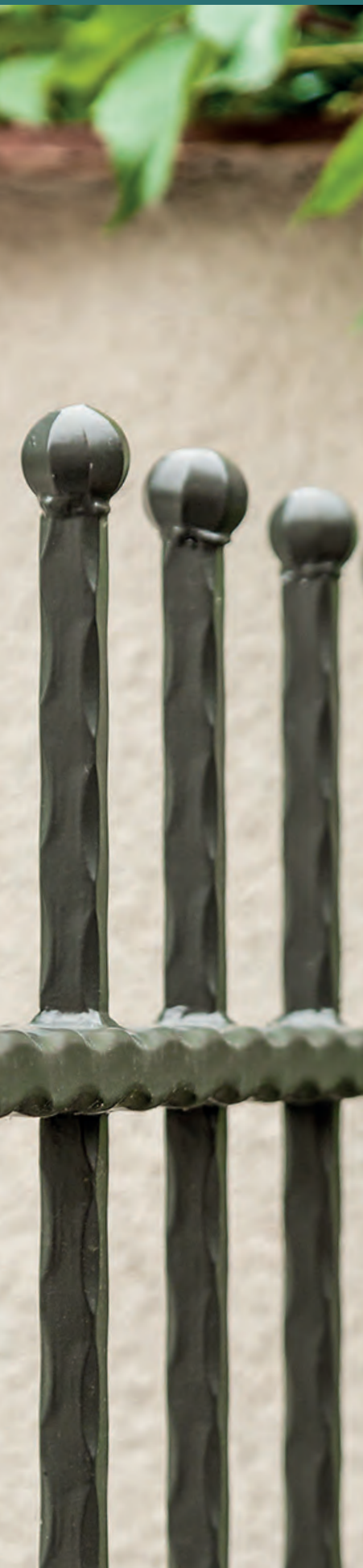

□	N°
ø15	<b>43.015</b>
ø20	<b>43.020</b>
ø25	<b>43.025</b>
ø30	<b>43.030</b>
ø35	<b>43.035</b>
ø40	<b>43.040</b>
ø50	<b>43.050</b>

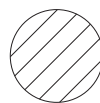
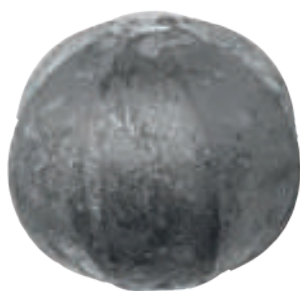

□	N°
ø20	<b>43.120</b>
ø25	<b>43.125</b>
ø30	<b>43.130</b>
ø35	<b>43.135</b>
ø40	<b>43.140</b>
ø50	<b>43.150</b>

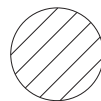

□	N°
ø30	<b>43.230</b>
ø40	<b>43.240</b>
ø50	<b>43.250</b>



≠	□	N°
1	ø40	<b>N 43.504</b>
1	ø50	<b>43.505</b>
1	ø60	<b>43.506</b>
1	ø70	<b>43.507</b>
1	ø80	<b>43.508</b>
1	ø100	<b>43.510</b>
1	ø120	<b>43.512</b>
1	ø150	<b>43.515</b>

# GĄŁKI I KULE

knobs and spheres / верхушки и шары / Pfostenaufsätze und Kugeln



93

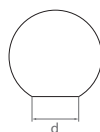

□	d	N°
ø15	8x8	<b>43.615</b>
ø20	10x10	<b>43.620</b>
ø25	14x14	<b>43.625</b>
ø30	14x14	<b>43.630</b>
ø35	16x16	<b>43.635</b>

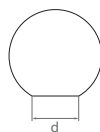

□	d	N°
ø40	ø20	<b>43.640</b>
ø50	ø25	<b>43.650</b>
ø60	ø30	<b>43.660</b>
ø70	ø35	<b>43.670</b>
ø80	ø40	<b>43.680</b>
ø90	ø45	<b>43.690</b>
ø100	ø53	<b>43.700</b>
ø120	ø61	<b>43.720</b>
ø150	ø80	<b>43.750</b>

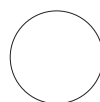

□	N°
ø60	<b>43.660.01</b>
ø80	<b>43.680.01</b>
ø100	<b>43.700.01</b>
ø120	<b>43.720.01</b>
ø200	<b>43.800.01</b>





# MASKOWNICE

masking frames  
маскировочные элементы  
Abschlußrosetten

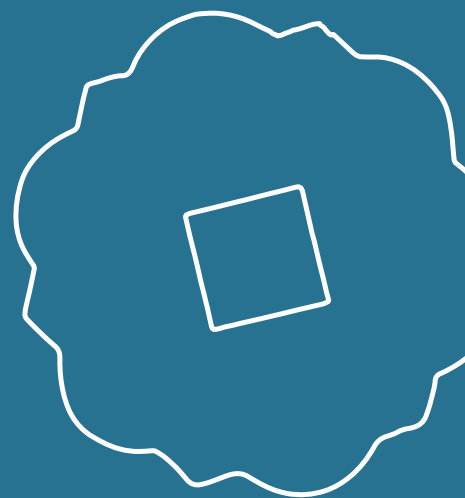

44.001 - 44.259.ZN

POSTAL<sup>®</sup>

# MASKOWNICE

masking frames / маскировочные элементы / Abschlußrosetten



≠	6	6	8
□	12x12	21x21	26x26
H	50	70	90
L	50	70	90
N°	<b>44.001</b>	<b>44.004</b>	<b>44.006</b>



≠	4	10	10
□			31x31
H	80	100	100
L	80	100	100
N°	<b>44.010</b>	<b>44.011</b>	<b>44.013</b>



≠	4	4	4
□		13x13	
H	78	78	100
L	78	78	100
N°	<b>44.017</b>	<b>44.018</b>	<b>44.020</b>

# MASKOWNICE

masking frames / маскировочные элементы / Abschlußrosetten

97



≠	4	4	4	4
□				26x26
H	∅67	∅95	∅108	∅105
N°	<b>44.026</b>	<b>44.029</b>	<b>44.034</b>	<b>44.036</b>



≠	8	8	4	2
H	85	120	60	76
L	85	120	60	76
N°	<b>44.038</b>	<b>44.039</b>	<b>44.040</b>	<b>44.043</b>



# MASKOWNICE

masking frames / маскировочные элементы / Abschlußrosetten



□	H	L	N°
12,5x12,5/3	12	50x50	<b>44.046</b>
14,5x14,5/3	13	50x50	<b>44.047</b>
16,5x16,5/3	13	50x50	<b>44.048</b>
20,5x20,5/4	17	80x80	<b>44.049</b>
25,5x25,5/4	17	80x80	<b>44.050</b>
30,5x30,5/4	16	80x80	<b>44.051</b>
40,5x40,5/4	17	80x80	<b>44.052</b>



□	H	L	N°
40,5x20,5/4	17	80x80	<b>44.053</b>
30,5x40,5/3	17	80x80	<b>44.054</b>



□	H	L	N°
30,5x30,5	20	80x80	<b>44.119</b>
40,5x40,5	20	80x80	<b>44.121</b>
25,5x25,5	20	60x60	<b>44.122</b>
30,5x30,5	20	60x60	<b>44.123</b>
20,5x20,5	20	50x50	<b>44.126</b>
12,5x12,5	15	40x40	<b>44.127</b>
14,5x14,5	15	40x40	<b>44.128</b>
16,5x16,5	15	40x40	<b>44.129</b>



# MASKOWNICE

masking frames / маскировочные элементы / Abschlußrosetten



99



H	L	N°
20	ø60	<b>44.134</b>
20	ø40	<b>44.136</b>



□	H	L	N°
ø12,5	15	ø50	<b>44.138</b>
ø14	15	ø50	<b>44.139</b>
ø25	25	ø80	<b>44.140</b>
ø32	25	ø80	<b>44.141</b>
ø38	30	ø97	<b>44.142</b>
ø42	30	ø97	<b>44.143</b>
ø48	30	ø97	<b>44.144</b>
ø51	30	ø110	<b>44.145</b>



□	H	L	N°
12x12	19	44x44	<b>44.146</b>
12x12	19	44x44	<b>44.146.ZN</b>
14x14	19	44x44	<b>44.147</b>
14x14	19	44x44	<b>44.147.ZN</b>
16x16	19	44x44	<b>44.148</b>
16x16	19	44x44	<b>44.148.ZN</b>
20x20	18	58x58	<b>44.149</b>
20x20	18	58x58	<b>44.149.ZN</b>
25x25	30	80x80	<b>44.150</b>
25x25	30	80x80	<b>44.150.ZN</b>
30x30	30	80x80	<b>44.151</b>
30x30	30	80x80	<b>44.151.ZN</b>
40x40	30	90x90	<b>44.152</b>
40x40	30	90x90	<b>44.152.ZN</b>
50x50	30	100x100	<b>44.153</b>
60x60	28	109x109	<b>44.154</b>
80x80	28	120x120	<b>44.155</b>
80x80	28	120x120	<b>44.155.ZN</b>
100x100	28	140x140	<b>44.156</b>

# MASKOWNICE

masking frames / маскировочные элементы / Abschlußrosetten



□	H	L	N°
40x30	30	75x85	<b>44.157</b>
40x60	28	90x110	<b>44.158</b>
20x40	28	100x100	<b>44.159</b>



□	≠	L	N°
12x12	1	40x40	<b>44.230.ZN</b>
14x14	1	40x40	<b>44.231.ZN</b>
16x16	1	40x40	<b>44.232.ZN</b>
20x20	1	40x40	<b>44.233.ZN</b>
12x12	1	50x50	<b>44.234.ZN</b>
14x14	1	50x50	<b>44.235.ZN</b>
16x16	1	50x50	<b>44.236.ZN</b>
20x20	1	50x50	<b>44.237.ZN</b>
20x20	1	50x50	<b>44.238.ZN</b>
20x20	1	60x60	<b>44.239.ZN</b>
30x30	1	60x60	<b>44.240.ZN</b>
40x40	1	60x60	<b>44.241.ZN</b>
50x50	1	60x60	<b>44.242.ZN</b>
20x20	1	70x70	<b>44.243.ZN</b>
30x30	1	70x70	<b>44.244.ZN</b>
50x50	1	70x70	<b>44.246.ZN</b>
20x20	1	80x80	<b>44.247.ZN</b>
30x30	1	80x80	<b>44.248.ZN</b>
40x40	1	80x80	<b>44.249.ZN</b>
20x20	1	100x100	<b>44.251.ZN</b>
30x30	1	100x100	<b>44.252.ZN</b>
50x50	1	100x100	<b>44.254.ZN</b>
20x20	1	120x120	<b>44.256.ZN</b>
30x30	1	120x120	<b>44.257.ZN</b>
40x40	1	120x120	<b>44.258.ZN</b>
50x50	1	120x120	<b>44.259.ZN</b>

# MASKOWNICE

masking frames / маскировочные элементы / Abschlußrosetten

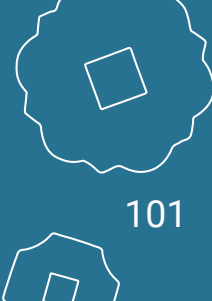

101



#	4	4	6	3	3
□	14,5x14,5				
L		70	105	102	30
H	∅90	155	160	160	135
N°	<b>44.060</b>	<b>44.200</b>	<b>44.205</b>	<b>44.206</b>	<b>44.220</b>



#	4	4	4	5
L	50	60	85	110
H	120	145	200	250
N°	<b>44.201</b>	<b>44.202</b>	<b>44.203</b>	<b>44.204</b>



# KWIATY I LIŚCIE

flowers and leaves  
ЦВЕТЫ И ЛИСТЬЯ  
Blumen und Blätter



50.000 - 51.452

POSTAL®



≠	1,2	5	5	4	2	2
□					∅10	∅10
H	∅40	∅95	∅95	∅62	∅60	∅45
N°	<b>50.000</b>	<b>50.001</b>	<b>50.003</b>	<b>50.004</b>	<b>50.005</b>	<b>50.006</b>

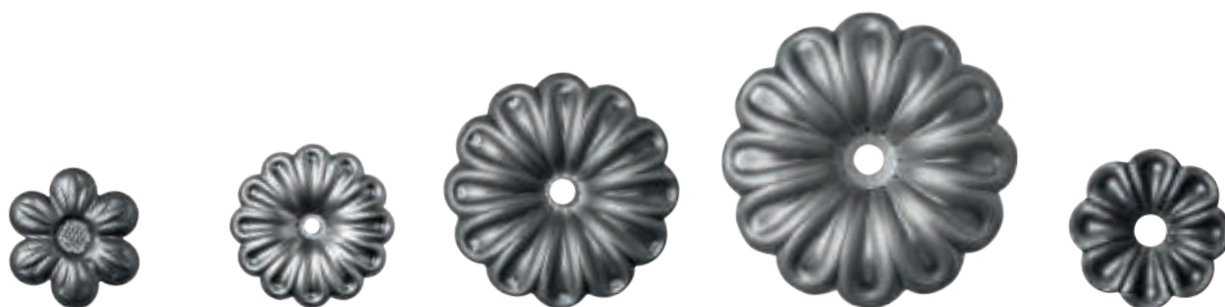

≠	2	1,2	2	2	2
□		∅5,5	∅10	∅12	∅12
H	∅57	∅66	∅95	∅120	∅60
N°	<b>50.009</b>	<b>50.010</b>	<b>50.011</b>	<b>50.012</b>	<b>50.014</b>



≠	2	2	2	1,5	0,8	0,8
□		∅10	∅10	∅8	∅8	∅7,5
H	∅100	∅140	∅85	∅45	∅70	∅110
N°	<b>50.021</b>	<b>50.021.01</b>	<b>50.022</b>	<b>50.023</b>	<b>50.024</b>	<b>50.025</b>

# KWIATY I LIŚCIE

flowers and leaves / цветы и листья / Blumen und Blätter

105



#	0,8	0,8	0,8
□	∅5	∅10	∅20
H	∅46	∅70	∅115
N°	<b>50.029</b>	<b>50.030</b>	<b>50.031</b>

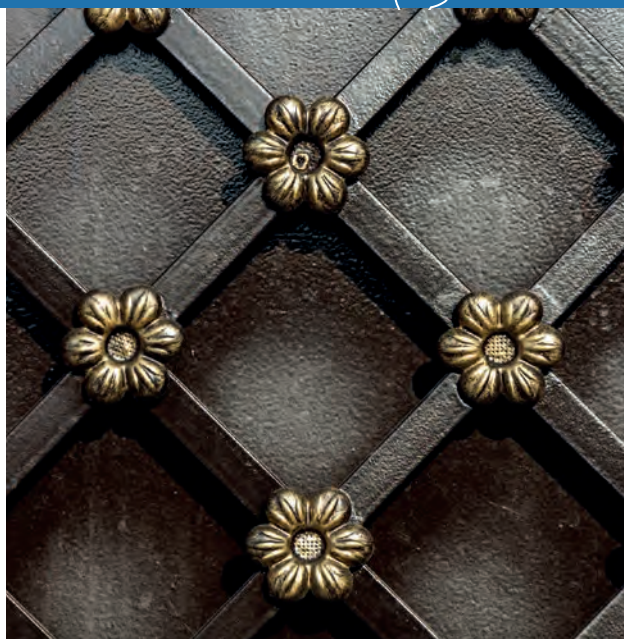

#	2	2	0,8
□	∅7	∅7	
H	∅87	∅120	∅100
N°	<b>50.042</b>	<b>50.043</b>	<b>50.051</b>



#	2	2	2
□			
H	∅85	∅115	∅95
N°	<b>50.054</b>	<b>50.055</b>	<b>50.056</b>





≠	1,5	1,5	1,5
□	95	75	50
H	170	190	140
N°	<b>50.062</b>	<b>50.063</b>	<b>50.064</b>



≠	1,2	1,2	1,2
H	ø60	ø50	ø35
N°	<b>50.095</b>	<b>50.096</b>	<b>50.097</b>



L	200	70	125	45
H	450	100	200	60
N°	<b>50.100</b>	<b>50.101</b>	<b>50.102</b>	<b>50.103</b>

# KWIATY I LIŚCIE

flowers and leaves / цветы и листья / Blumen und Blätter

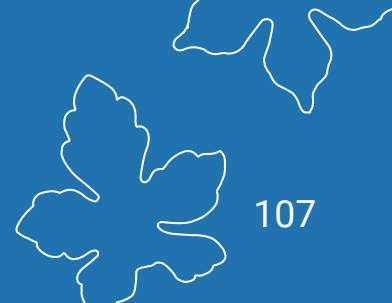

107



≠			2	2	
L	140	30	50	40	
H	200	75	125	80	
N°	<b>50.104</b>	<b>50.105</b>	<b>50.106</b>	<b>50.107</b>	



≠	2	2	1	1,5	
L	50	35	33	50	90
H	115	80	45	50	340
N°	<b>50.111</b>	<b>50.112</b>	<b>50.108</b>	<b>50.110</b>	<b>50.109</b>



≠	2,5	
L	40	140
H	80	320
N°	<b>50.122</b>	<b>50.124</b>



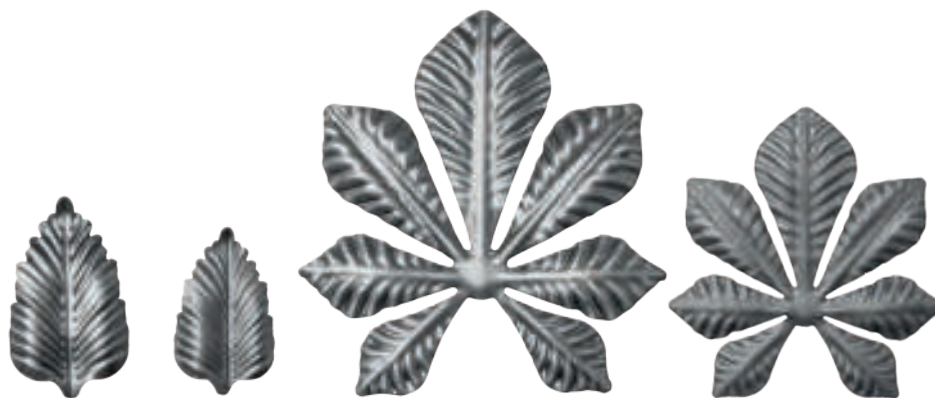

№	2	2	2	2
L	70	50	220	150
H	115	85	210	160
N°	<b>50.133</b>	<b>50.134</b>	<b>50.136</b>	<b>50.138</b>



№	2,5	2,5	2,5
L	40	37	30
H	130	115	90
N°	<b>50.143</b>	<b>50.143.01</b>	<b>50.143.02</b>



№	25	20	2	2	2
L			90	75	55
H	95	56	170	140	100
N°	<b>50.153</b>	<b>50.154</b>	<b>50.150</b>	<b>50.151</b>	<b>50.152</b>

# KWIATY I LIŚCIE

flowers and leaves / цветы и листья / Blumen und Blätter

109



≠	2	2	2	2
L	150	115	95	70
H	150	125	85	70
N°	<b>50.156</b>	<b>50.157</b>	<b>50.158</b>	<b>50.159</b>



≠	1,5	1,5	1,5	60	60
L	100	75	50	160	120
H	105	75	50		
N°	<b>50.160</b>	<b>50.161</b>	<b>50.162</b>	<b>50.165</b>	<b>50.166</b>



≠	12	12	2	2
L	190	190	110	75
H	430	430	155	115
N°	<b>50.175</b>	<b>50.176</b>	<b>50.182</b>	<b>50.183</b>



≠			2			
L	170	105	45	75	110	110
H	410	275	250	210	200	200
N°	<b>50.188</b>	<b>50.189</b>	<b>50.190</b>	<b>50.195</b>	<b>50.196</b>	<b>50.197</b>



≠	2	2	2
L	200	140	142
H	115	85	150
N°	<b>50.200</b>	<b>50.201</b>	<b>50.210</b>



# KWIATY I LIŚCIE

flowers and leaves / цветы и листья / Blumen und Blätter



111



≠	2	2	2
L	140	105	70
H	120	90	60
N°	<b>50.211</b>	<b>50.212</b>	<b>50.213</b>



≠	2	2	2	2
L	200	155	125	95
H	190	165	135	100
N°	<b>50.216</b>	<b>50.217</b>	<b>50.218</b>	<b>50.219</b>





≠	2	2
L	54	55
H	130	130
N°	<b>50.229</b>	<b>50.230</b>



≠	2,5	2,5	2,5	2,5
L	140	70	150	70
H	200	190	260	240
N°	<b>50.236</b>	<b>50.237</b>	<b>50.238</b>	<b>50.239</b>



≠	2,5	2,5	2,5	2,5
L	120	60	60	85
H	370	350	350	280
N°	<b>50.240</b>	<b>50.241</b>	<b>50.242</b>	<b>50.243</b>

# KWIATY I LIŚCIE

flowers and leaves / цветы и листья / Blumen und Blätter

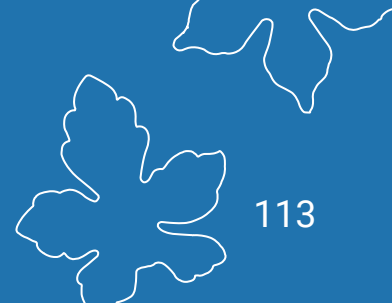

113



≠	2,5	2,5
L	50	50
H	250	250
N°	<b>50.244</b>	<b>50.245</b>



≠	2,5	2,5	2,5	2,5
L	200	200	100	100
H	210	210	270	270
N°	<b>50.255</b>	<b>50.256</b>	<b>50.257</b>	<b>50.258</b>





≠	2,5	2,5	2	2	2	2
L	50	50	92	92	60	60
H	90	90	112	112	80	80
N°	<b>51.003</b>	<b>51.004</b>	<b>51.015</b>	<b>51.016</b>	<b>51.017</b>	<b>51.018</b>



≠	2	2	2	2	2	2
L	69	69	40	40	30	30
H	185	185	110	110	90	90
N°	<b>51.059</b>	<b>51.060</b>	<b>51.061</b>	<b>51.062</b>	<b>51.063</b>	<b>51.064</b>



≠	2	2	2	2	2	2
L	60	60	70	70	75	75
H	80	80	65	65	110	110
N°	<b>51.069</b>	<b>51.070</b>	<b>51.073</b>	<b>51.074</b>	<b>51.077</b>	<b>51.078</b>

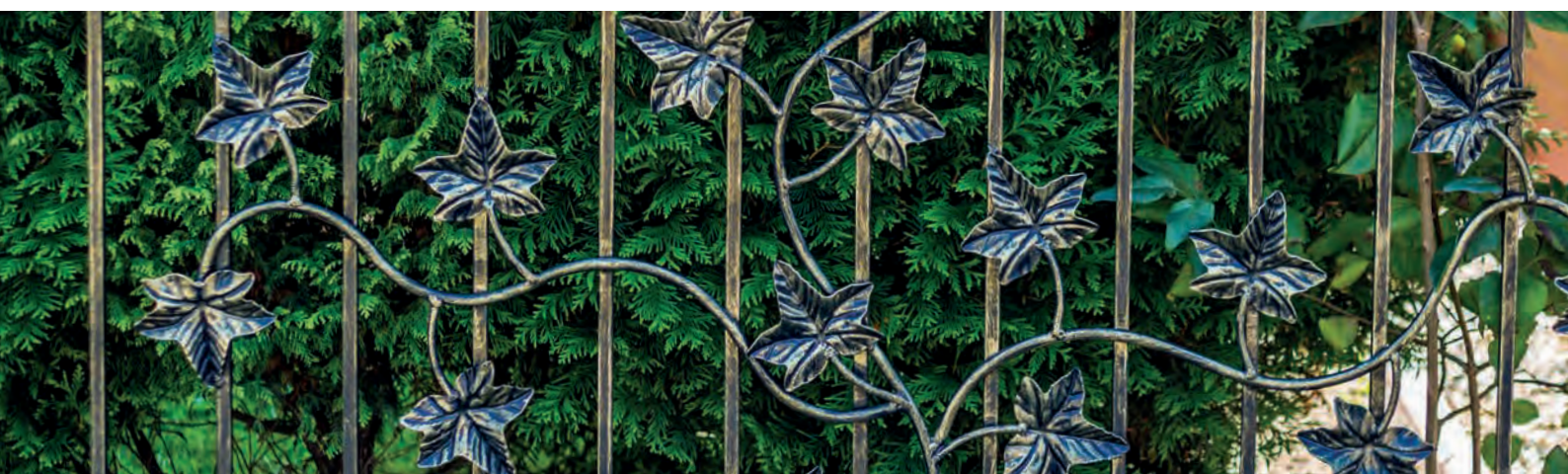

# KWIATY I LIŚCIE

flowers and leaves / цветы и листья / Blumen und Blätter



115

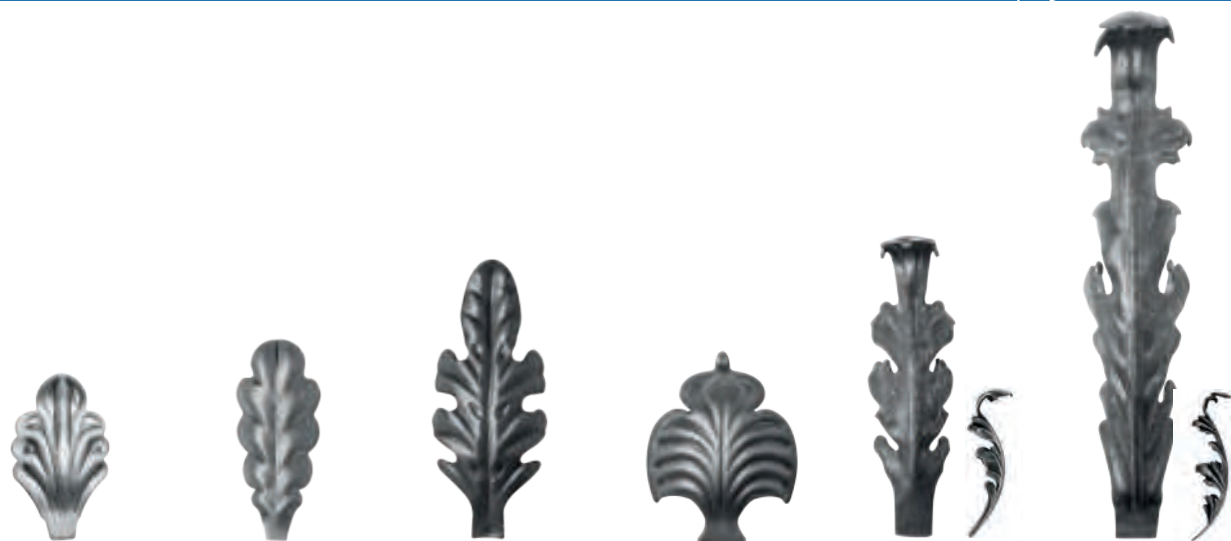

≠	2	2	2	2	2	2
L	48	45	47	72	45	60
H	88	108	150	100	160	280
N°	<b>51.079</b>	<b>51.080</b>	<b>51.082</b>	<b>51.083</b>	<b>51.097</b>	<b>51.098</b>



≠	3	2,5	2,5	2,5	3	3
L	50	38	60	75	60	55
H	105	125	150	150	300	290
N°	<b>51.099</b>	<b>51.101</b>	<b>51.102</b>	<b>51.103</b>	<b>51.104</b>	<b>51.105</b>





≠	4	4	4	2	1,5
L	110	92	100	100	135
H	350	295	330	260	70
N°	<b>51.106</b>	<b>51.107</b>	<b>51.108</b>	<b>51.108.01</b>	<b>51.110</b>



≠	1,8	1,8	4	4
L	150	150	175	175
H	100	100	215	215
N°	<b>51.113</b>	<b>51.114</b>	<b>51.115</b>	<b>51.116</b>



# KWIATY I LIŚCIE

flowers and leaves / цветы и листья / Blumen und Blätter



117



#	2	2	2	2
L	95	95	175	175
H	200	200	295	295
N°	<b>51.121</b>	<b>51.122</b>	<b>51.123</b>	<b>51.124</b>



#	2	2	2	2
L	135	135	130	130
H	230	230	164	164
N°	<b>51.125</b>	<b>51.126</b>	<b>51.127</b>	<b>51.128</b>

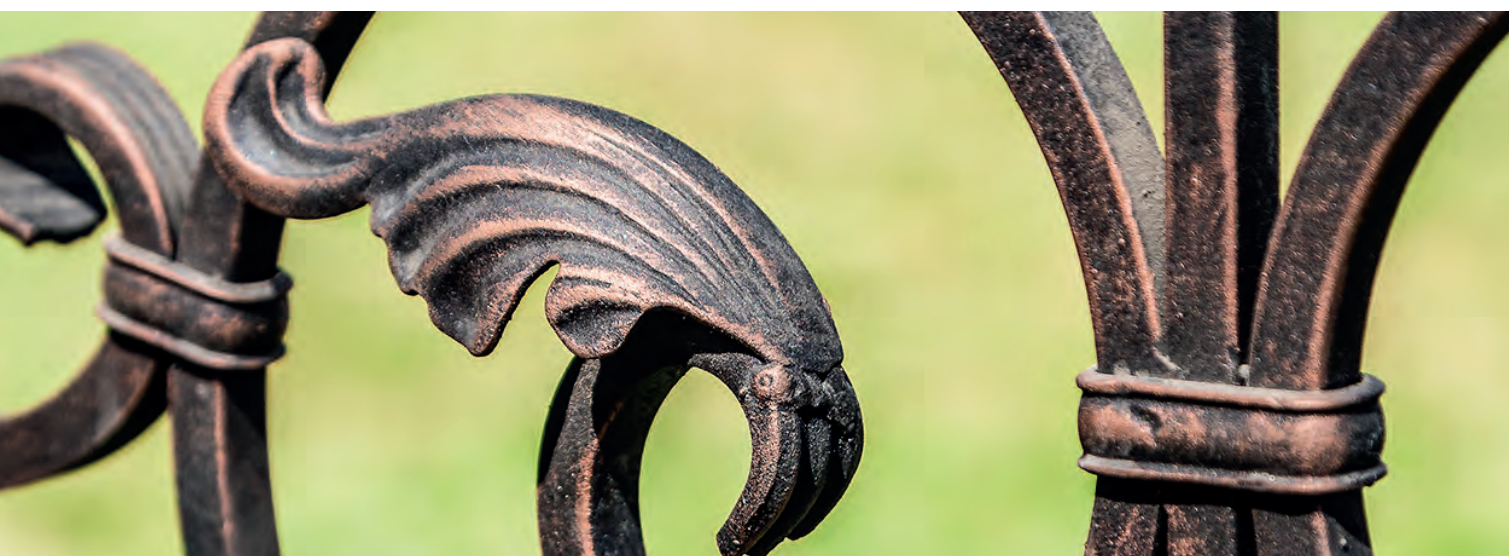



≠	2	2	2	2
L	140	140	140	140
H	240	240	240	240
N°	<b>51.129</b>	<b>51.130</b>	<b>51.133</b>	<b>51.134</b>



≠	2	2	2	2	2
L	75	50	50	56	70
H	260	255	235	285	240
N°	<b>51.140</b>	<b>51.143</b>	<b>51.144</b>	<b>51.145</b>	<b>51.147</b>



# KWIATY I LIŚCIE

flowers and leaves / цветы и листья / Blumen und Blätter

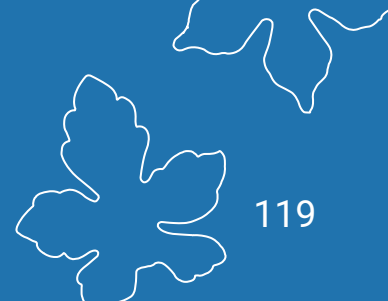

119



≠	2	2	2	2
L	95	95	130	72
H	110	110	143	85
N°	<b>51.153</b>	<b>51.154</b>	<b>51.235</b>	<b>51.236</b>



≠	2	2	2	1,2
L	210	210	145	180
H	340	340	243	260
N°	<b>51.240</b>	<b>51.241</b>	<b>51.251</b>	<b>51.252</b>





≠	2	2	0,8
L	180	165	110
H	260	165	110
N°	<b>51.253</b>	<b>51.254</b>	<b>51.418</b>



≠	1,2	2
L	300	50
H	225	225
N°	<b>51.451</b>	<b>51.452</b>



≠	0,8
L	570
H	120
N°	<b>51.427</b>



≠	0,8
L	1000
H	80
N°	<b>51.449</b>



**STAR FLEX** 

**NIEZAWODNE TARCZE DO CIĘCIA I SZLIFOWANIA**



# ODLEWY STALIWNE I ŻELIWNE

cast steel items and cast iron items  
литая сталь и чугунные элементы  
Stahlguss und Gusseisenwaren

52.003 - 55.200

POSTAL<sup>®</sup>



≠	4	4	4	4
L	95	95	155	155
H	120	120	280	280
N°	<b>52.003</b>	<b>52.004</b>	<b>52.005</b>	<b>52.006</b>



≠	4	4	4	4
L	65	65	115	115
H	140	140	175	175
N°	<b>52.009</b>	<b>52.010</b>	<b>52.011</b>	<b>52.012</b>



≠	4	4	4	4
L	110	110	160	160
H	140	140	190	190
N°	<b>52.013</b>	<b>52.014</b>	<b>52.015</b>	<b>52.016</b>

# ODLEWY STALIWNE

cast steel items / литая сталь / Stalguss

125



≠	4	4	4	4
L	140	140	150	150
H	155	155	250	250
N°	<b>52.017</b>	<b>52.018</b>	<b>52.019</b>	<b>52.020</b>



≠	4	4	4	4
L	120	120	85	85
H	210	210	180	180
N°	<b>52.021</b>	<b>52.022</b>	<b>52.023</b>	<b>52.024</b>



≠	4	4	4	4
L	125	125	140	75
H	165	165	215	170
N°	<b>52.025</b>	<b>52.026</b>	<b>52.029</b>	<b>52.030</b>



≠	4	4	4	4
L	105	48	60	75
H	235	120	190	135
N°	<b>52.034</b>	<b>N 52.043.01</b>	<b>52.044</b>	<b>52.047</b>



≠	4	4	4	4
L	120	120	∅150	∅90
H	210	211		45
N°	<b>52.049</b>	<b>52.050</b>	<b>52.130</b>	<b>52.131</b>



≠	3	4,5	5	3
H	∅90	∅90	∅115	∅50
N°	<b>52.132</b>	<b>52.133</b>	<b>52.134</b>	<b>52.139</b>

# ODLEWY STALIWNE

cast steel items / литея сталь / Stalguss

127



≠	4	2	4
L	75	110	80
H	125	155	122
N°	<b>52.201</b>	<b>52.202</b>	<b>52.203</b>



L	100	140
H	145	200
N°	<b>52.211</b>	<b>52.212</b>



□	∅5	∅5
L	28	43
H	180	160
N°	<b>52.216</b>	<b>52.217</b>





≠	8	8	8
H	ø85	ø55	ø93
N°	<b>52.300</b>	<b>52.301</b>	<b>52.305</b>



≠	8	10
L	100	135
H	195	210
N°	<b>52.406</b>	<b>52.420</b>



≠	0,5	0,5	0,5
L		45	35
H	ø80	85	70
N°	<b>53.000</b>	<b>53.008</b>	<b>53.009</b>

# ODLEWY ŻELIWNE

cast iron items / чугунные элементы / Gusseisenwaren

129

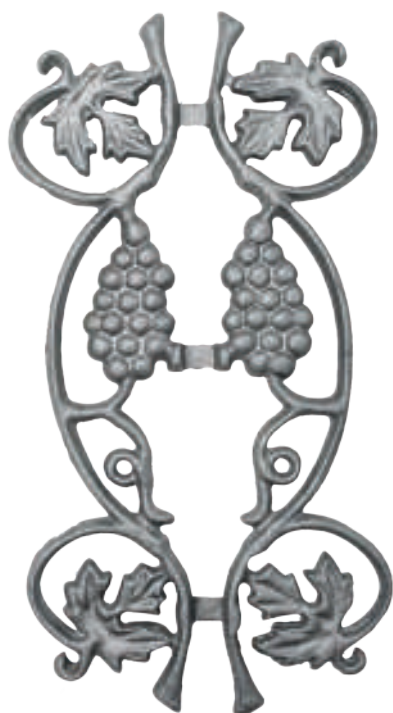

≠	14x14	14x14	14x14
L	190	175	200
H	380	400	455
N°	<b>55.001</b>	<b>55.003</b>	<b>55.005</b>



≠	14x14	14x14	14x14	14x14
L	138	130	225	180
H	165	280	315	260
N°	<b>55.006</b>	<b>55.007</b>	<b>55.008</b>	<b>55.009</b>

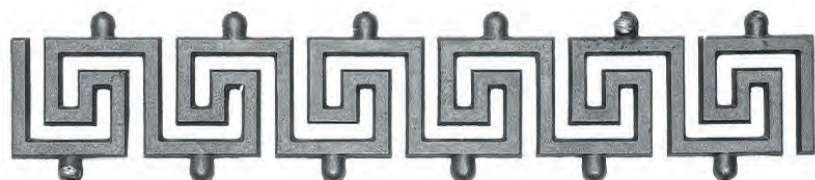

H	108
L	500
N°	<b>55.030</b>

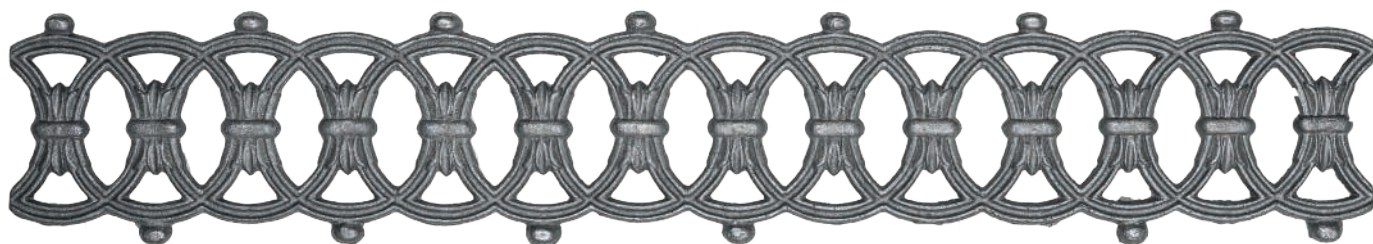

H	150
L	870
N°	<b>55.031</b>

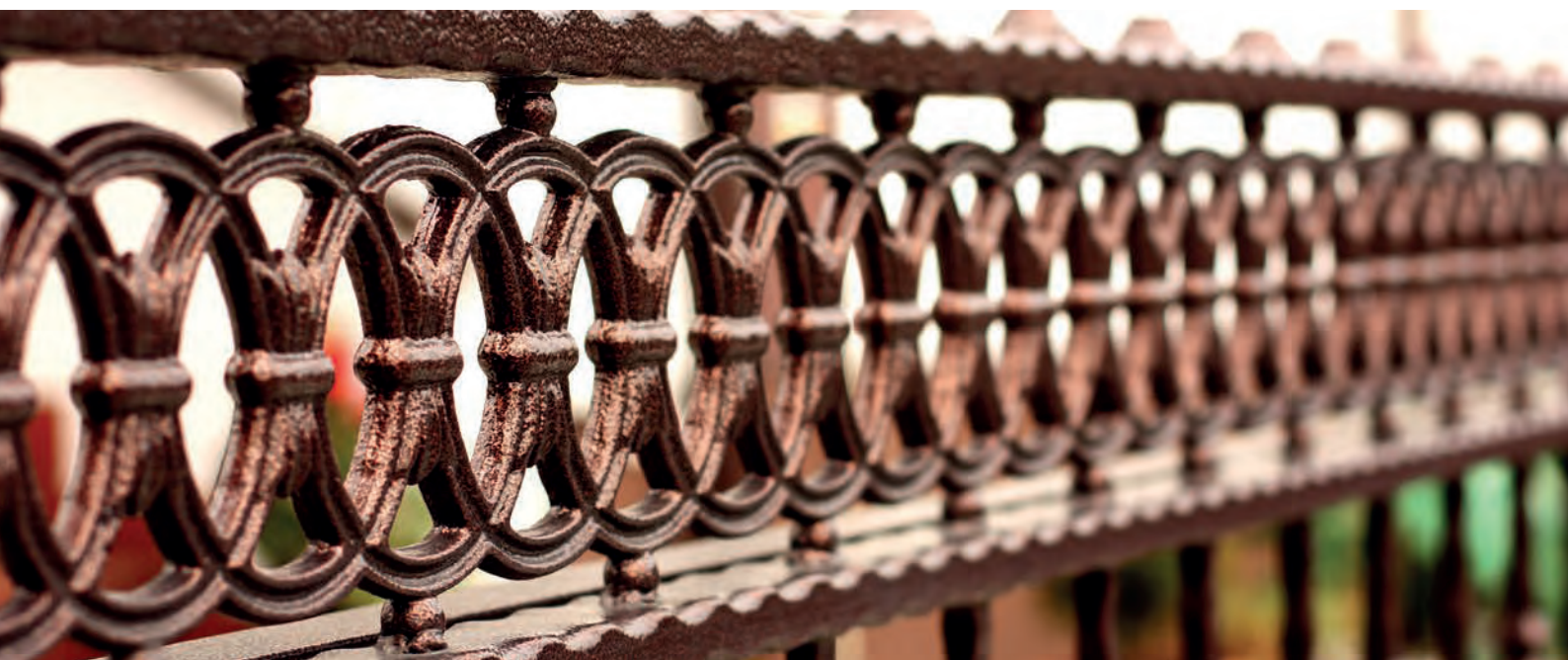

# ODLEWY ŻELIWNE

cast iron items / чугунные элементы / Gusseisenwaren

131



L		165
H	∅120	250
N°	<b>55.050</b>	<b>55.200</b>



□	∅100
L	110
H	210
N°	<b>55.100</b>



□	40	50	60	80	100
L	40	50	60	80	100
H	87	110	135	160	180
N°	<b>55.101</b>	<b>55.102</b>	<b>55.103</b>	<b>55.104</b>	<b>55.105</b>

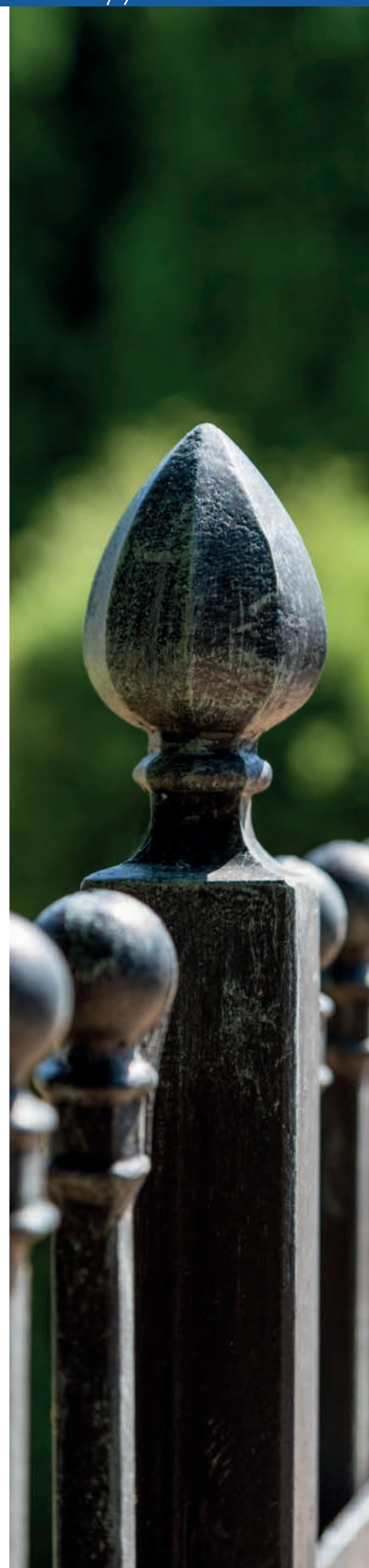

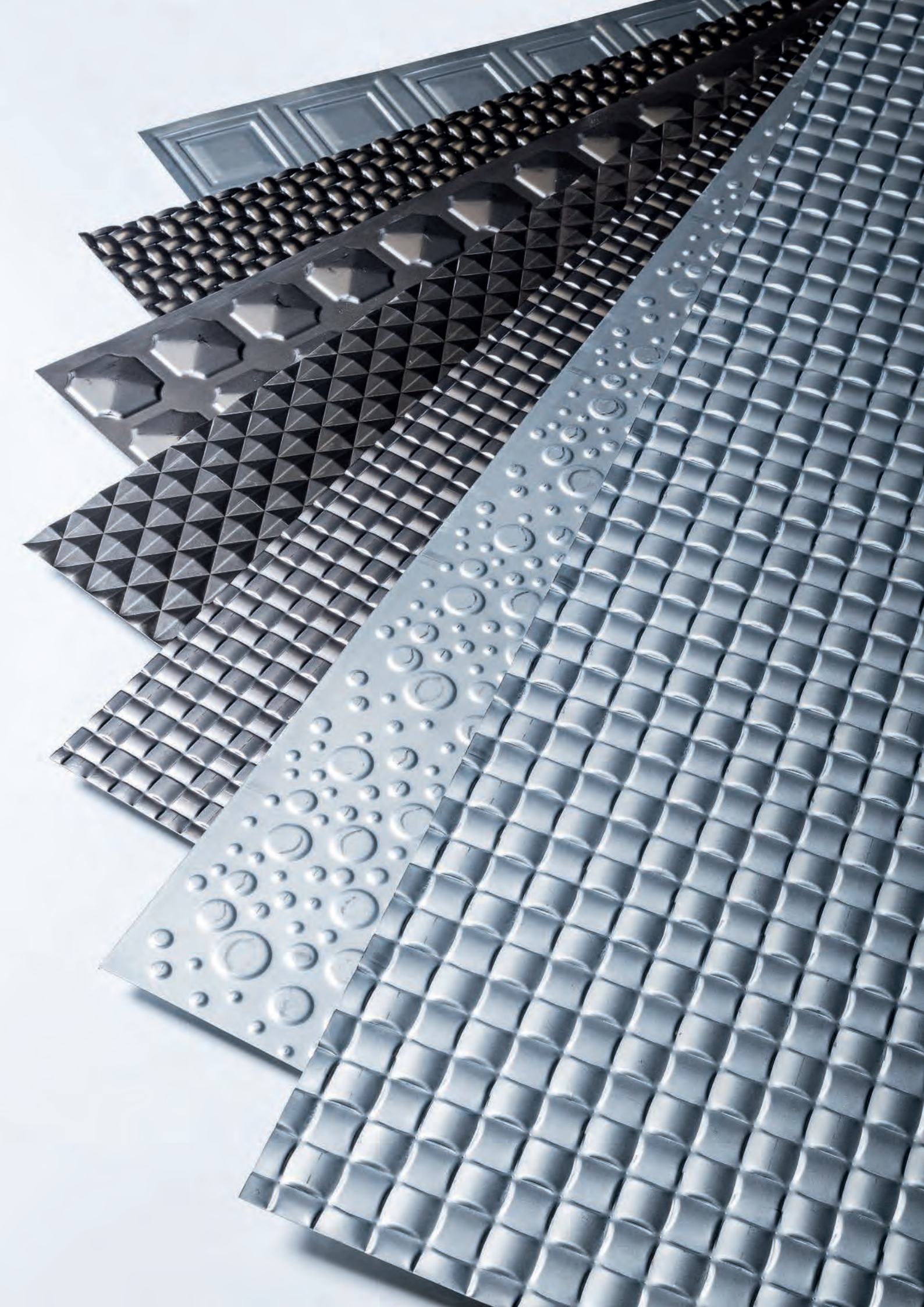

# BLACHY

metal sheets  
листовой металл  
Stahlblech

56.010 - 56.090.12.01

POSTAL<sup>®</sup>

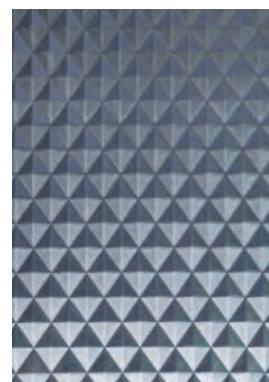
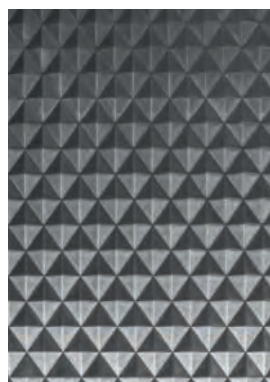
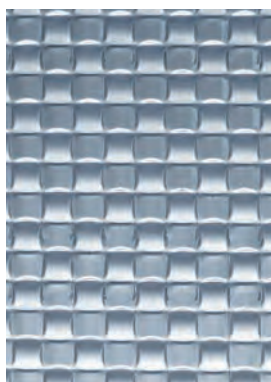
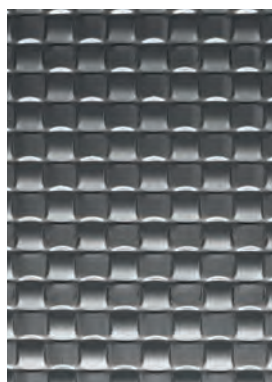

ocynk / galvanized

ocynk / galvanized

□	1,2	1,2	1,2	1,2
H	2000	2000	2000	2000
L	1000	1000	1000	1000
N°	<b>56.010.12</b>	<b>56.010.12.01</b>	<b>56.020.12</b>	<b>56.020.12.01</b>

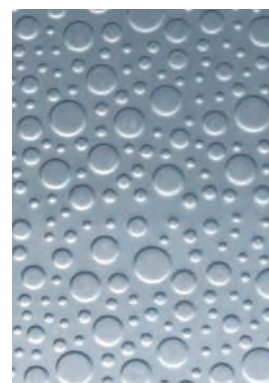
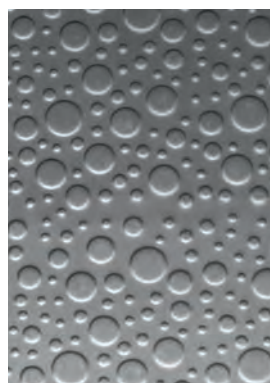

ocynk / galvanized

□	1,2	1,2	1,2
H	2000	2000	2000
L	1000	1000	1000
N°	<b>56.030.12</b>	<b>56.040.12</b>	<b>56.040.12.01</b>



# BLACHY

metal sheets / листовый металл / Stahlblech

135

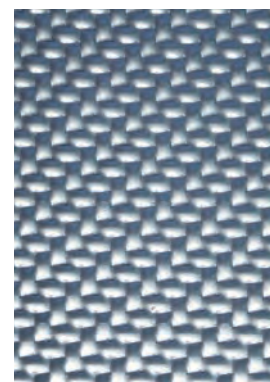
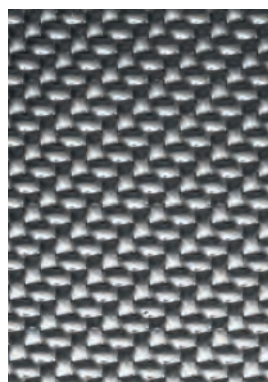
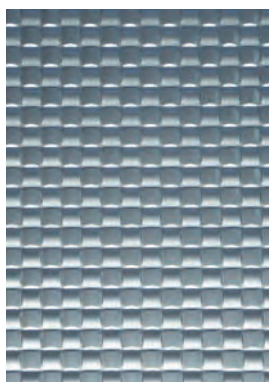
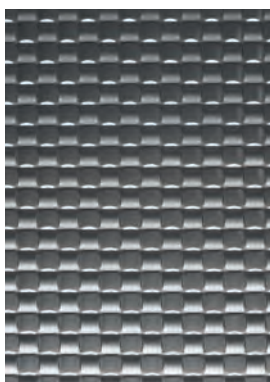

ocynk / galvanized

ocynk / galvanized

□	1,2	1,2	1,2	1,2
H	2000	2000	2000	2000
L	1000	1000	1000	1000
N°	<b>56.050.12</b>	<b>56.050.12.01</b>	<b>56.060.12</b>	<b>56.060.12.01</b>

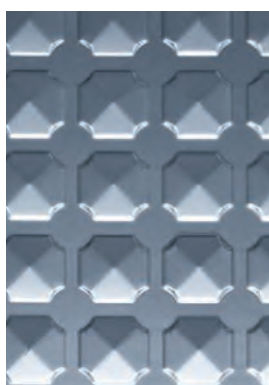

ocynk / galvanized

ocynk / galvanized

□	1,2	1,2	1,2	1,2
H	2000	2000	2000	2000
L	1000	1000	1000	1000
N°	<b>56.070.12</b>	<b>56.070.12.01</b>	<b>56.080.12</b>	<b>56.080.12.01</b>



ocynk / galvanized

□	1,2	1,2
H	2000	2000
L	1000	1000
N°	<b>56.090.12</b>	<b>56.090.12.01</b>



Czekamy na Ciebie! Zaloguj się na naszą platformę zakupową [www.bonmario.com](http://www.bonmario.com) lub zadzwoń do swojego Opiekuna!



### Wózki

Cantilever gate carriages / Несущие каретки / Laufrollenböcke



### Uchwyty i najazdy

Guide wheels and end stops / Ловители и ролики / Auflaufelemente



### Rolki prowadzące

Nylon rollers / Ведущие ролики / Führungsrollen



### Szyny do bram

Rails for cantilever gates / Направляющие шины для ворот / Torprofile

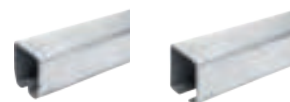

### Listwy zębate do bram

Gear Racks / Зубчатые рейки для ворот / Zahnstangen



akcesoria do bram i ogrodzeń  
hardware

**PSG**



### Rolki jezdne

Sliding gate wheels / Ролики / Torrollen



### System podwieszany

Hanging doors system / Подвесная система / Hängende Schiebetorsysteme



### Zawiasy regulowane

Adjustable hinges / Регулируемые петли / Scharniere einstellbar



### Stopery

Stoppers / Отбойники / Stopper



...i dużo więcej! / ...and much more!

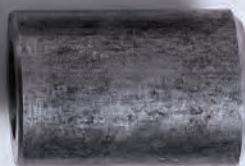
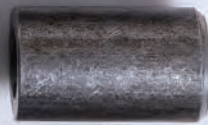
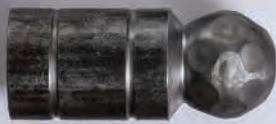

# ZAWIASY

# ТОЧЗОНЕ I PASOWE

hingos

петли

Scharniere und Ladenbänder

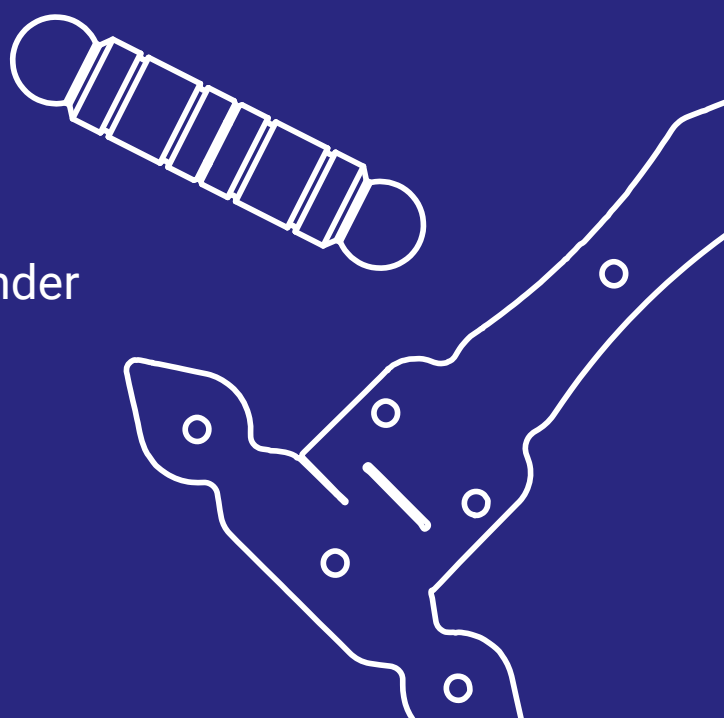

## 61.100 - 61.326

**PSG**

# ZAWIASY TOCZONE I PASOWE

hinges / петли / Scharniere und Ladenbänder

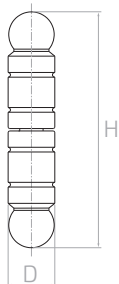

## Zawias ozdobny

Welding hinge /  
Петля приварная /  
Scharnier



	D	H
<b>61.100</b>	ø20	100
<b>61.101</b>	ø29	130

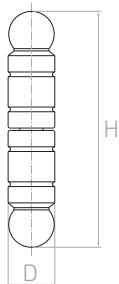

## Zawias ozdobny

Welding hinge /  
Петля приварная /  
Scharnier



	D	H
<b>61.102</b>	ø20	100
<b>61.103</b>	ø24	122
<b>61.104</b>	ø30	146
<b>61.105</b>	ø30	230

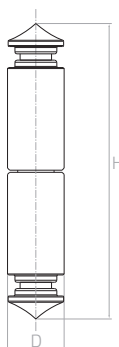

## Zawias ozdobny z kulą

Welding hinge with ball /  
Петля приварная с шаром /  
Scharnier mit Kugel



	D	S
<b>61.106</b>	ø27	145
<b>61.107</b>	ø35	190

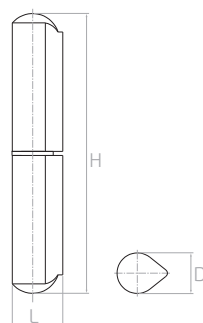

## Zawias do spawania

Welding hinge /  
Петля приварная /  
Scharnier



	L	D	H
<b>61.116.02</b>	20	ø16	120
<b>61.120.02</b>	25	ø20	140
<b>61.124.02</b>	28	ø23	200

# ZAWIASY TOCZONE I PASOWE

hinges / петли / Scharniere und Ladenbänder

141

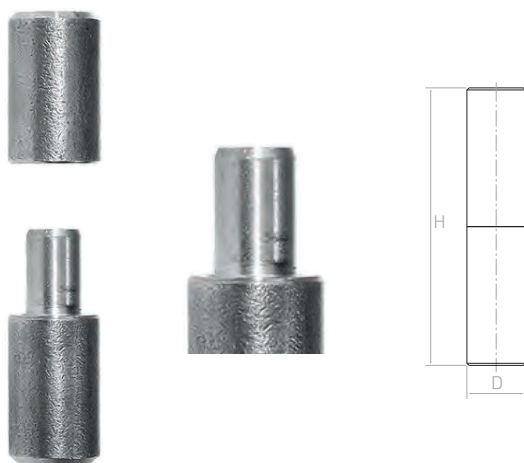

## Zawias toczony

Welding hinge / Петля точеная приварная / Scharnier



	D	H
<b>61.112</b>	ø12	60
<b>61.114</b>	ø14	70
<b>61.116</b>	ø16	66
<b>61.118</b>	ø18	80
<b>61.120</b>	ø20	70
<b>61.124</b>	ø24	80
<b>61.125</b>	ø25	100
<b>61.127</b>	ø27	90
<b>61.130</b>	ø30	100
<b>61.131</b>	ø30	120
<b>61.135</b>	ø35	120
<b>61.140</b>	ø40	120

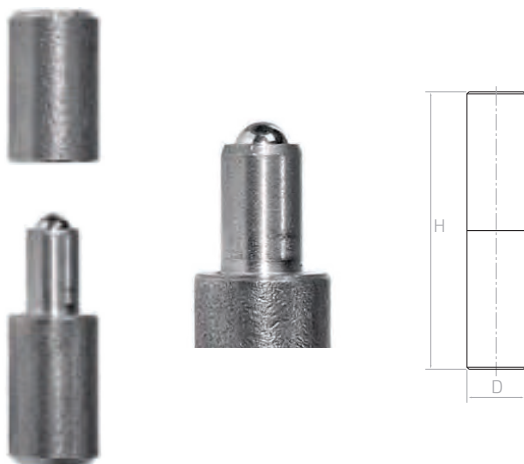

## Zawias toczony z kulą

Welding hinge with ball / Петля точеная приварная с шаром / Scharnier mit Kugel



	D	H
<b>61.114.01</b>	ø14	70
<b>61.116.01</b>	ø16	66
<b>61.118.01</b>	ø18	80
<b>61.120.01</b>	ø20	70
<b>61.124.01</b>	ø24	80
<b>61.125.01</b>	ø25	100
<b>61.127.01</b>	ø27	90
<b>61.130.01</b>	ø30	100
<b>61.131.01</b>	ø30	120
<b>61.135.01</b>	ø35	120
<b>61.140.01</b>	ø40	120



## Zawias skrzydełkowy

Welding hinge / Петля приварная / Scharnier



	L	D	A	S
<b>61.120.03</b>	120	20	46	4
<b>61.124.03</b>	140	24	76	5

# ZAWIASY TOCZONE I PASOWE

hingies / петли / Scharniere und Ladenbänder

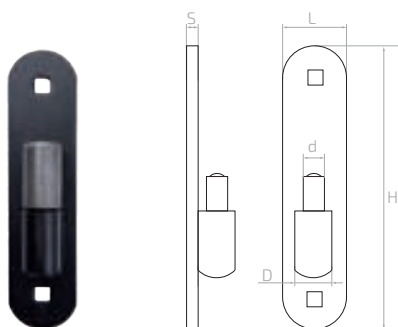

Zawias do przykręcenia  
Hinge / Петля / Scharnier



	d	D	H	L	≠
<b>61.201</b>		ø24	150	40	4
<b>61.202</b>	ø16	ø27	200	50	5,5

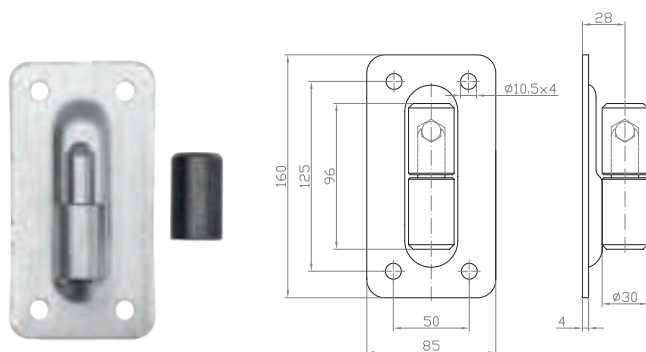

Zawias toczony, kulowy ø30  
Hinge / Петля / Scharnier



	H	L
<b>61.203</b>	160	85

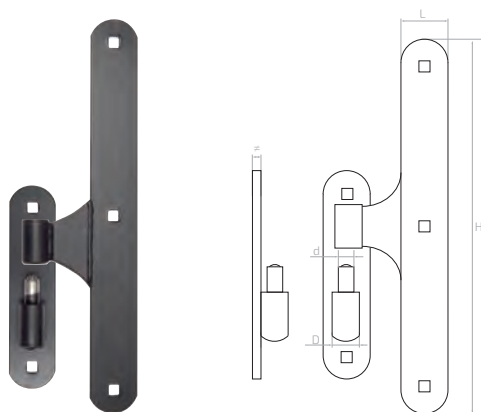

Zawias środkowy  
Hinge / Петля / Scharnier



	d	D	H	L	≠
<b>61.211</b>	ø16	ø27	400	50	5,5

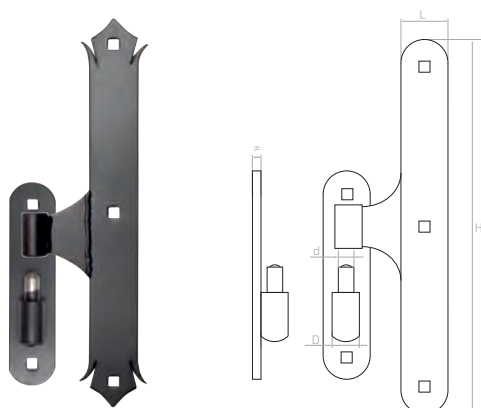

Zawias środkowy ozdobny  
Hinge / Петля / Scharnier



	d	D	H	L	S
<b>61.212</b>	ø16	ø27	400	50	5,5

# ZAWIASY TOCZONE I PASOWE

hinges / петли / Scharniere und Ladenbänder

143

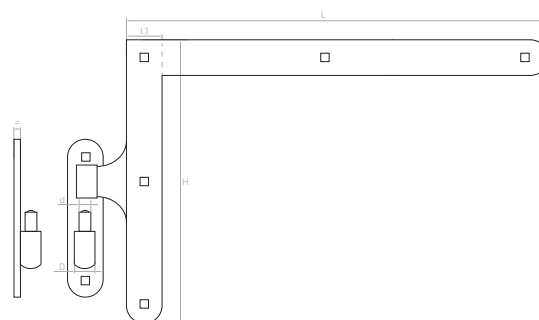
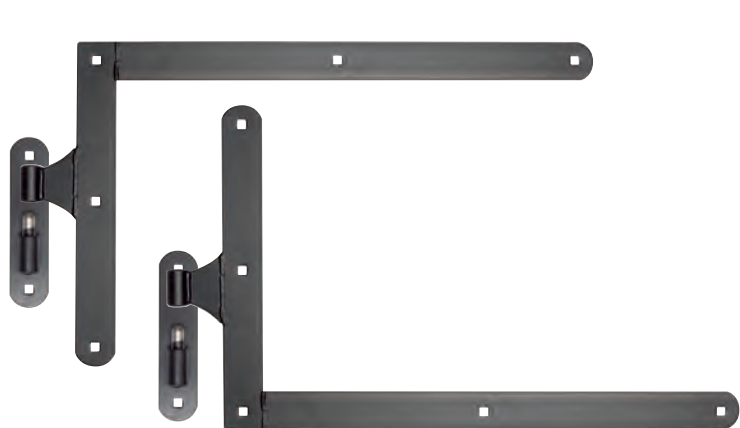

Zawiasy kątowe  
Hinge / Петля / Scharnier



	d	D	H	L	L1	≠
<b>N 61.221.02</b> górny i dolny/ up and down	ø16	ø27	400	650	50	5

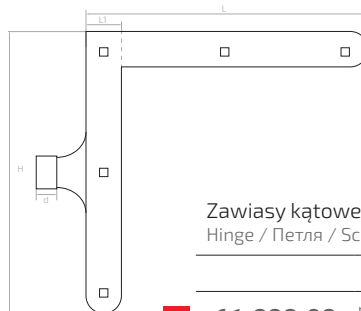

Zawiasy kątowe  
Hinge / Петля / Scharnier



	d	H	L	L1	≠
<b>N 61.222.02</b> prawy i lewy/ right and left	ø14	250	285	35	4

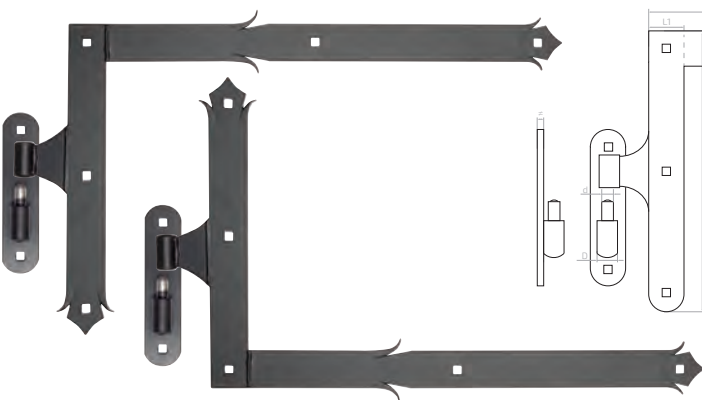

Zawiasy kątowe ozdobne  
Hinge / Петля / Scharnier



	d	D	H	L	L1	≠
<b>N 61.223.02</b> górny i dolny/ up and down	ø16	ø27	400	650	50	5

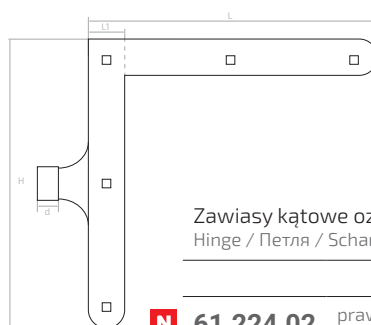
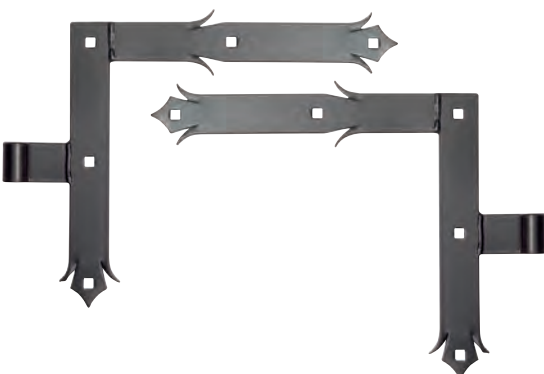

Zawiasy kątowe ozdobne  
Hinge / Петля / Scharnier



	d	H	L	L1	≠
<b>N 61.224.02</b> prawy i lewy/ right and left	ø14	250	285	35	4

# ZAWIASY TOCZONE I PASOWE

hinges / петли / Scharniere und Ladenbänder



Zawias pasowy  
Hinge / Петля / Torband



	d	L	H	≠
<b>61.251</b>	ø14	400	35	4



Zawias pasowy  
Hinge / Петля / Torband



	d	L	H	≠
<b>61.252</b>	ø14	600	35	4
<b>61.253</b>	ø18	800	40	5,5



Zawias pasowy  
Hinge / Петля / Torband



	d	L	H	≠
<b>61.254</b>	ø18	1000	50	5,5



Zawias pasowy  
Hinge / Петля / Torband



	d	L	H	≠
<b>61.255</b>	ø20	1150	60	6



Zawias pasowy ozdobny  
Hinge / Петля / Torband



	d	L	H	≠
<b>61.256</b>	ø14	500	35	4
<b>61.257</b>	ø18	700	50	5,5

# ZAWIASY TOCZONE I PASOWE

hinges / петли / Scharniere und Ladenbänder

145



## Czop do przykręcenia

Pin /  
Петлержатель прикручиваемый /  
Torband Dorn



	d	H	L	≠
<b>61.261</b>	ø14	35	150	4
<b>61.262</b>	ø18	40	200	5,5
<b>61.263</b>	ø18	50	230	6
<b>61.264</b>	ø20	60	280	8



## Czop do przykręcenia ozdobny

Pin /  
Петлержатель прикручиваемый /  
Torband Dorn



	d	H	L	≠
<b>61.265</b>	ø14	35	150	4



## Czop do wmurowania

Built-in pin /  
Петлержатель под застройку в стену /  
Torband Dorn zum Einbetonieren



	d	H	L	≠
<b>61.271</b>	ø14	35	150	5,5
<b>61.272</b>	ø18	40	200	6
<b>61.273</b>	ø18	50	215	6
<b>61.274</b>	ø20	60	270	8



## Wzmocnienie narożnika

Hinge / Петля / Torbeschlag



	H	L	≠
<b>61.300</b>	150	150	3
<b>61.301</b>	200	200	3

# ZAWIASY TOCZONE I PASOWE

hinges / петли / Scharniere und Ladenbänder



Zawias ozdobny  
Hinge / Петля / Scharnier



	L	H	≠
<b>61.302</b>	165	184	3
<b>61.303</b>	215	248	3



Zawias ozdobny pasowy  
Hinge / Петля / Torband



	L	H	≠
<b>61.304</b>	218	125	3

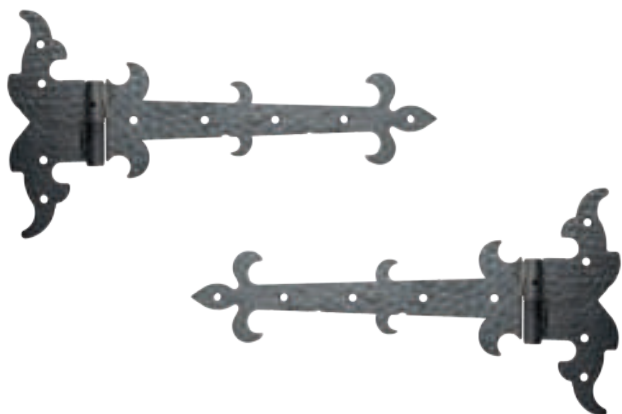

Zawias ozdobny pasowy  
Hinge / Петля / Torband



	L	H	≠
<b>61.305</b> lewy left / левая / Links	342	178	3
<b>61.306</b> prawy right / правая / Recht	342	178	3

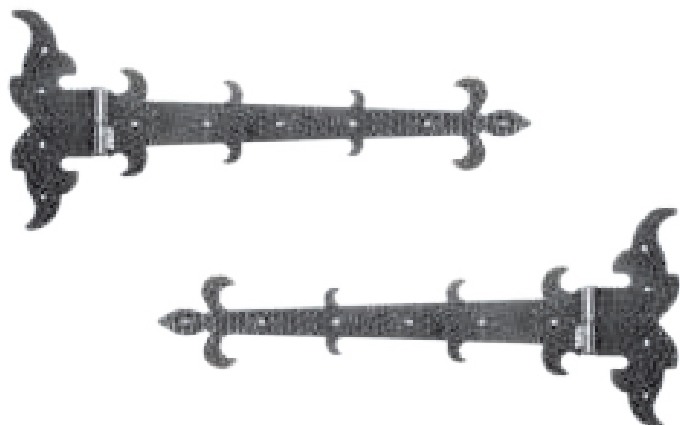

Zawias ozdobny pasowy  
Hinge / Петля / Torband



	L	H	≠
<b>61.307</b> lewy left / левая / Links	525	225	3
<b>61.308</b> prawy right / правая / Recht	525	225	3

# ZAWIASY TOCZONE I PASOWE

hinges / петли / Scharniere und Ladenbänder

147



Zawias ozdobny pasowy  
Hinge / Петля / Torband



	L	H	≠
<b>61.314</b>	217	148	3



Zawias ozdobny pasowy  
Hinge / Петля / Torband



		L	H	≠
<b>61.315</b>	lewy left / левая / Links	357	207	3
<b>61.316</b>	prawy right / правая / Recht	357	207	3



Zawias ozdobny pasowy  
Hinge / Петля / Torband



		L	H	≠
<b>61.317</b>	lewy left / левая / Links	500	270	3
<b>61.318</b>	prawy right / правая / Recht	500	270	3



# ZAWIASY TOCZONE I PASOWE

hinges / петли / Scharniere und Ladenbänder



Zawias krzyżowy altanowy  
Hinge / Петля / Torband



	L	H	≠
<b>N</b> 61.320	280	280	2,8



Zawias altanowy  
Hinge / Петля / Torband



	L	H	≠
<b>N</b> 61.321	255	90	2,8

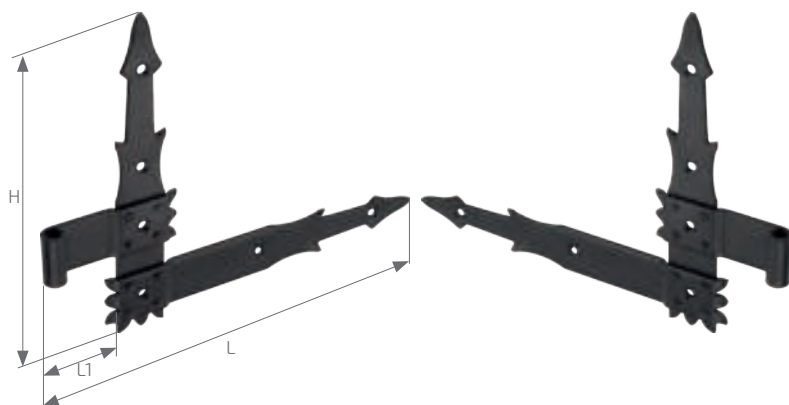

Zawias kątowy okiennicowy  
Hinge / Петля / Torband



		d	L	L1	H	≠
<b>N</b> 61.322	lewý left / левая / Links	ø9	295	45	220	2,8
<b>N</b> 61.323	prawy right / правая / Recht	ø9	295	45	220	2,8

# ZAWIASY TOCZONE I PASOWE

hinges / петли / Scharniere und Ladenbänder

149



Zaczep budowlany okiennicowy  
Pin / Петледержатель прикручиваемый /  
Torband Dorn



	d	H	L	≠
<b>N 61.324</b>	ø9	95	35	2,5



Zawias krzyżowy ozdobny  
Hinge / Петля / Torband



	d	H	L	≠
<b>N 61.325</b>	ø6	260	135	4



Zaczep budowlany okiennicowy  
Pin / Петледержатель прикручиваемый /  
Torband Dorn



	d	H	L	≠
<b>N 61.326</b>	ø6	120	40	4,5



Sprawdź pełną gamę zawiasów w katalogu  
Check the full range of hinges in the catalogue

**PSG**

# DASZKI

post caps, крышки, Deckel



więcej znajdziesz w katalogu PSG

	A	H	≠
<b>62.101</b>	180	170	3
<b>62.102</b>	150	165	3
<b>62.103</b>	130	140	3
<b>62.104</b>	110	125	3



# PINOX

ELEMENTY ZE STALI NIERDZEWNEJ

Zapytaj swojego Opiekuna o katalog produktów PINOX!



# KLAMKI I UCHWYTY

door handles  
ручки  
Türdrücker und Griffe



63.001 - 63.038

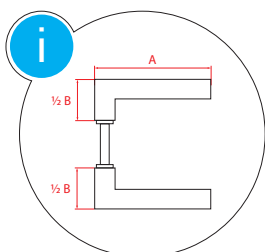

POSTAL<sup>®</sup>

# KLAMKI I UCHWYTY

door handles / ручки / Türdrücker und Griffe

i

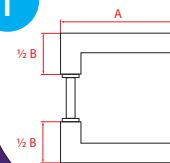

	A	B	
<b>63.001</b>	145	85	ocynk / galvanized



	A	B	
<b>63.003</b>	160	95	ocynk / galvanized



	A	B	
<b>63.005</b>	165	85	ocynk / galvanized



	A	B	
<b>63.006</b>	140	95	-
<b>63.006.01</b>	140	85	ocynk / galvanized



	A	B	
<b>63.007</b>	135	90	ocynk / galvanized



	A	B	
<b>63.012</b>	130	80	-

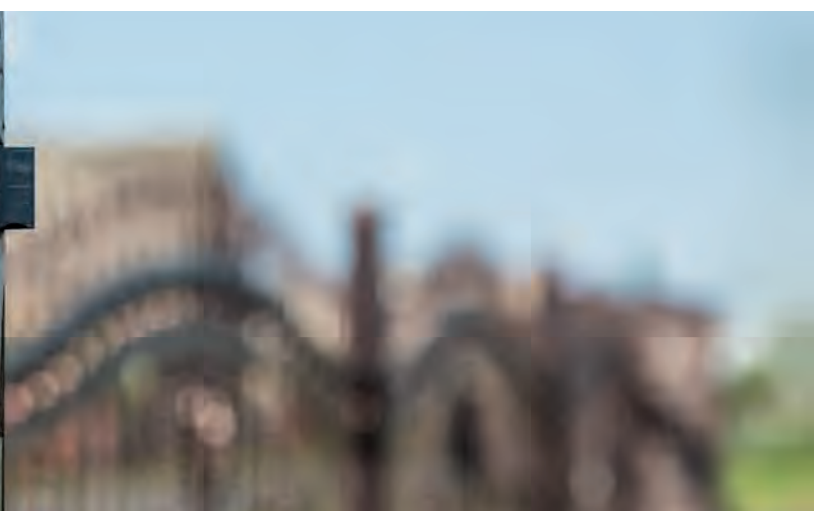

# KLAMKI I UCHWYTY

door handles / ручки / Türdrücker und Griffe



155



	A	B	
<b>63.013</b>	142	90	-



	A	B	
<b>N 63.013.01</b>	142	90	-



	A	B	
<b>63.021</b>	120	80	ocynk / galvanized



	A	B	
<b>63.022</b>	130	65	ocynk / galvanized



	A	B	
<b>63.029</b>	155	80	ocynk / galvanized



	A	B	
<b>63.030</b>	155	90	ocynk / galvanized



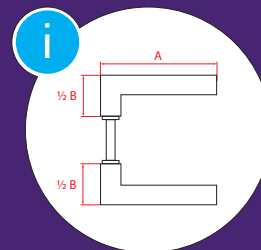

	A	B
<b>63.031</b>	150	80



	A	B	
<b>63.031.01</b>	150	70	ocynk / galvanized



	A	B
<b>63.032</b>	165	80



	A	B	
<b>63.034</b>	145	80	ocynk / galvanized



	A	B	
<b>63.038</b>	155	85	ocynk / galvanized



	A	B	
<b>63.035</b>	120	80	malowana / painted



	A	B	
<b>63.036</b>	120	80	malowana / painted



# KLAMKI I UCHWYTY

door handles / ручки / Türdrücker und Griffe



157



	H	L	
<b>63.002*</b>	60	ø 65	malowana / painted



	H	L	
<b>63.008</b>	85	ø 70	-

\* do wyprzedania zapasu



	H	L	
<b>63.009</b>	70	ø 70	-



	H	L	
<b>63.010</b>	65	ø 65	-



	H	L	
<b>63.011</b>	55	ø 70	-



	H	L	
<b>63.015</b>	70	105	-



# KLAMKI I UCHWYTY

door handles / ручки / Türdrücker und Griffe



	H	L	
<b>63.016</b>	110	105	-



	H	L	
<b>63.017</b>	60	ø 65	-



	H	L	
<b>63.018</b>	70	ø 65	-



	H	L	
<b>63.027</b>	80	ø 68	-



	H	L	
<b>63.028</b>	100	ø 68	-



	H	L	
<b>63.020</b>	55	65	-



# KLAMKI I UCHWYTY

door handles / ручки / Türdrücker und Griffe



159



	H	L	
63.024	290	80	-



	H	L	
63.025	390	75	-



Sprawdź pełną gamę klamek w katalogu  
Check the full range of door handles in the catalogue

**PSG**





# SZYLDY

shields  
накладки  
Schlosskastenblenden



63.040 - 63.194.90.00

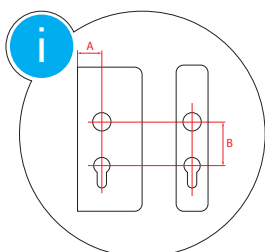

**PSG**

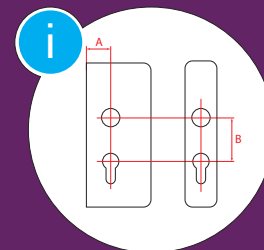

1

2

N		D	≠
1	<b>63.040</b>	∅ 65	2
2	<b>63.041</b>	∅ 65	2



1

2

N		D	≠
1	<b>63.044</b>	∅ 52	3
2	<b>63.045</b>	∅ 52	3



H

L

≠

**63.142**

230

40

5



1



2

N		H	L	≠
1	<b>63.046</b>	105	37	3
2	<b>63.047</b>	105	37	3



H

L

≠

B

**63.138.72.00**

263

60

3

72

**63.138.90.00**

263

60

3

90



H

L

≠

B

**63.139.72.00**

260

52

3

72

**63.139.90.00**

260

52

3

90



H

L

≠

B

**63.140.72.00**

263

50

3

72

**63.140.90.00**

263

50

3

90



H

L

≠

B

**63.141.90.00**

260

56

3

90

# SZYLDY

shields / накладки / Schlosskastenblenden

163



1 2

N		H	L	≠	A	B
1	<b>63.165.72.50</b>	295	136	2	50	72
2	<b>63.166.72.50</b>	295	136	2	50	72

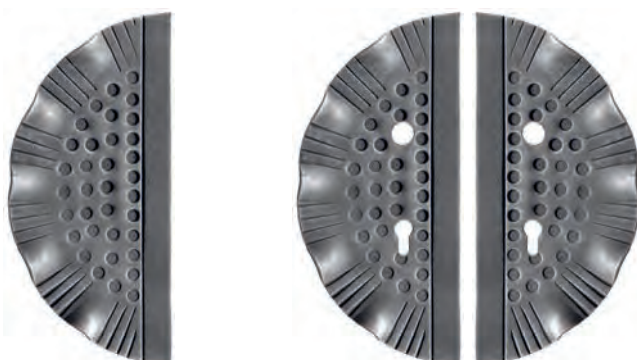

1 2 3

N		H	L	≠	A	B
1	<b>63.101.00.00</b>	272	125	2,5	-	-
2	<b>63.102.72.50</b>	272	125	2,5	50	72
3	<b>63.103.72.50</b>	272	125	2,5	50	72
2	<b>63.102.90.50</b>	272	125	2,5	50	90
3	<b>63.103.90.50</b>	272	125	2,5	50	90

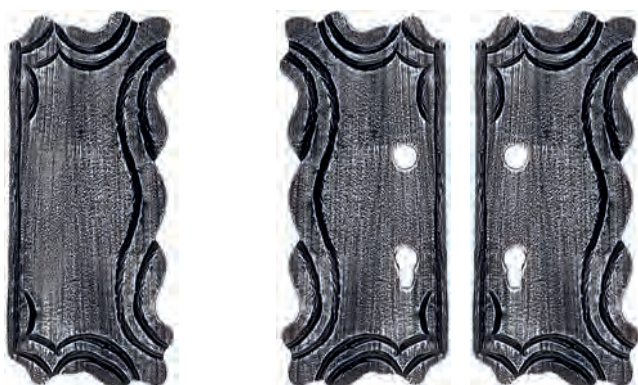

1 2 3

N		H	L	≠	A	B
1	<b>63.108.00.00</b>	322	141	3	-	-
2	<b>63.109.72.50</b>	322	141	3	50	72
3	<b>63.110.72.50</b>	322	141	3	50	72
2	<b>63.109.90.50</b>	322	141	3	50	90
3	<b>63.110.90.50</b>	322	141	3	50	90



1 2 3

N		H	L	≠	A	B
1	<b>63.111.00.00</b>	320	98	3	-	-
2	<b>63.112.90.50</b>	320	98	3	50	90
3	<b>63.113.90.50</b>	320	98	3	50	90

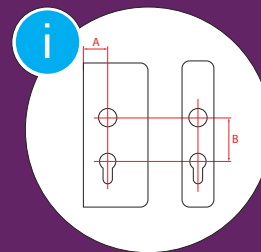

1



2

3

N		H	L	≠	A	B
1	<b>63.114.00.00</b>	288	123	3	-	-
2	<b>63.115.90.35</b>	288	123	3	35	90
3	<b>63.116.90.35</b>	288	123	3	35	90



1



2

3

N		H	L	≠	A	B
1	<b>63.146.00.00</b>	320	98	3	-	-
2	<b>63.149.72.50</b>	317	135	2	50	72
3	<b>63.150.72.50</b>	317	135	2	50	72
2	<b>63.147.90.50</b>	317	135	2	50	90
3	<b>63.148.90.50</b>	317	135	2	50	90



1



2

3

N		H	L	≠	A	B
1	<b>63.185.00.00</b>	310	116	2	-	-
2	<b>63.186.90.50</b>	310	116	2	50	90
3	<b>63.187.90.50</b>	310	116	2	50	90



1

2



3

4

N		H	L	≠	A	B
1	<b>63.117.00.00</b>	272	160	2,5	-	-
2	<b>63.118.00.00</b>	272	160	2,5	-	-
3	<b>63.119.72.50</b>	272	160	2,5	50	72
4	<b>63.120.72.50</b>	272	160	2,5	50	72
3	<b>63.119.90.50</b>	272	160	2,5	50	90
4	<b>63.120.90.50</b>	272	160	2,5	50	90

# SZYLDY

shields / накладки / Schlosskastenblenden

165



1 2 3 4

N		H	L	≠	A	B
1	<b>63.125.00.00</b>	285	160	2	-	-
2	<b>63.126.00.00</b>	285	160	2	-	-
3	<b>63.127.72.50</b>	285	160	2	50	72
4	<b>63.128.72.50</b>	285	160	2	50	72
3	<b>63.127.90.50</b>	285	160	2	50	90
4	<b>63.128.90.50</b>	285	160	2	50	90



1 2 3 4

N		H	L	≠	A	B
1	<b>63.134.00.00</b>	286	158	2	-	-
2	<b>63.135.00.00</b>	286	158	2	-	-
3	<b>63.136.72.50</b>	286	158	2	50	72
4	<b>63.137.72.50</b>	286	158	2	50	72
3	<b>63.136.90.50</b>	286	158	2	50	90
4	<b>63.137.90.50</b>	286	158	2	50	90



1 2 3 4

N		H	L	≠	A	B
1	<b>63.151.00.00</b>	330	172	2	-	-
2	<b>63.152.00.00</b>	330	172	2	-	-
3	<b>63.153.72.50</b>	330	172	2	50	72
4	<b>63.154.72.50</b>	330	172	2	50	72
3	<b>63.153.90.50</b>	330	172	2	50	90
4	<b>63.154.90.50</b>	330	172	2	50	90



1 2 3 4 5

N		H	L	≠	A	B
1	<b>63.129.00.00</b>	272	110	2,5	-	-
2	<b>63.130.00.50</b>	272	110	2,5	50	-
3	<b>63.131.00.50</b>	272	110	2,5	50	-
4	<b>63.130.72.50</b>	272	110	2,5	50	72
5	<b>63.131.72.50</b>	272	110	2,5	50	72
4	<b>63.130.90.50</b>	272	110	2,5	50	90
5	<b>63.131.90.50</b>	272	110	2,5	50	90

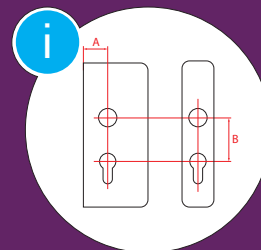

## Szyld z gałką ruchomą

Door knob with shield / Ручка с накладкой / Türgriff mit Rosette

	H	L	A	B	
<b>63.188.90.00</b>	270	36	100	90	malowany / painted



## Szyld z klamką i gałką ruchomą

Door handle and knob with shield / Ручка с накладкой / Türdrücker, Griff mit Rosette

	H	L	A	B	
<b>63.189.90.00</b>	270	36	100	90	malowany / painted



## Szyld z klamką

Door handle with shield / Ручка с накладкой / Türdrücker mit Rosette

	H	L	A	B	
<b>63.190.90.00</b>	270	36	100	90	malowany / painted



1

2

## Szyld z klamką

Door handle with shield / Ручка с накладкой / Türdrücker mit Rosette

N		H	L	≠	B
1	<b>63.191.72.00</b>	263	60	3	72
2	<b>63.192.72.00</b>	263	60	3	72
1	<b>63.191.90.00</b>	263	60	3	90
2	<b>63.192.90.00</b>	263	60	3	90

# SZYLDY

shields / накладки / Schlosskastenblenden

167

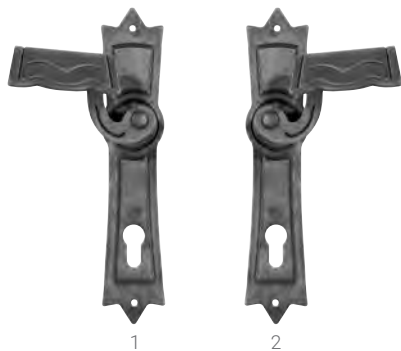

## Szyld z klamką

Door handle with shield / Ручка с накладкой / Türdrücker mit Rosette

N		H	L	≠	B
1	<b>63.193.90.00</b>	260	52	3	90
2	<b>63.194.90.00</b>	260	52	3	90



## Szyldy z klamkami

Door handle with shield / Ручка с накладкой / Türdrücker mit Rosette

	H	L	B	
<b>63.180.72.00</b>	240	30	72	malowana / painted
<b>63.180.90.00</b>	240	30	90	malowana / painted



## Szyldy z klamką i gałką stałą

Door handle and knob with shield / Ручка с накладкой / Türdrücker, Griff mit Rosette

	H	L	B	
<b>63.181.72.00</b>	240	30	72	malowana / painted
<b>63.181.90.00</b>	240	30	90	malowana / painted



## Szyldy z gałkami stałymi

Door knob with shield / Ручка с накладкой / Türgriff mit Rosette

	H	L	B	
<b>63.182.72.00</b>	240	30	72	malowana / painted
<b>63.182.90.00</b>	240	30	90	malowana / painted



## Łącznik

Welding lug / Соединитель / Anschweislasche

	H	L	≠
<b>64.003</b>	50	25	5
<b>64.004</b>	50	30	5



## Łącznik do zawiasu

Welding lug / Соединитель / Anschweislasche

	M	H	L	≠
<b>64.014</b>	16	100	40	8
<b>64.015</b>	18	90	60	8
<b>64.016</b>	20	90	60	8



## Łącznik do zawiasu

Welding lug / Соединитель / Anschweislasche

	M	H	L	≠
<b>N 64.017</b>	16	75	40	8



## Łącznik do zawiasu

Welding lug / Соединитель / Anschweislasche

	M	H	L	≠
<b>N 64.018</b>	20	120	120	8

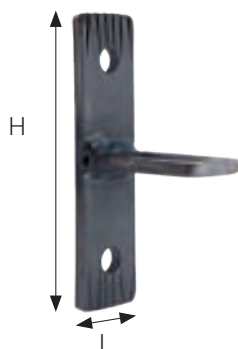

## Element ozdobny kuty

Decorative element / Соединитель / Lasche

	H	L	≠
<b>64.005</b>	102	25	5

# AKCESORIA MOCUJĄCE

fixing elements / крепления / Befestigungszubehör

169

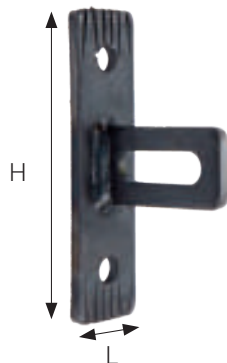

## Element ozdobny kuty

Decorative element / Соединитель / Lasche

	H	L	≠
<b>64.006</b>	102	25	5



## Mocowanie pręśta rozporowe

Finishing element / Пристенное крепление / Lasche mit Dübel

	H	L	∅	
<b>64.007</b>	130	25	∅ 12	ocynk / galvanized
<b>64.008</b>	130	30	∅ 12	ocynk / galvanized



## Uchwyt montażowy szeroki (2 śruby)

Mounting bracket / Монтажный кронштейн / Montagehalterung

	H	L	≠
<b>N 64.800</b>	60	25	4



## Uchwyt montażowy szeroki ozdobny

Mounting bracket / Монтажный кронштейн / Montagehalterung

	H	L	≠
<b>N 64.801</b>	95	28	4



## Łącznik pręśta ogrodzeniowego – do przykręcenia

Mounting bracket / Монтажный кронштейн / Montagehalterung

	H	L	≠
<b>N 64.019</b>	80	25	3

# AKCESORIA MOCUJĄCE

fixing elements / крепления / Befestigungszubehör



□	12x12	12x12	∅14
L	95	95	95
H	180	180	180
N°	<b>64.011</b>	<b>64.012</b>	<b>64.013</b>



□	∅6	∅6	∅6	∅10	∅10
L	∅19	∅25	∅18	∅21	19
H	36	25	36	32	30
N°	<b>64.020</b>	<b>64.021</b>	<b>64.022</b>	<b>64.023</b>	<b>64.024</b>

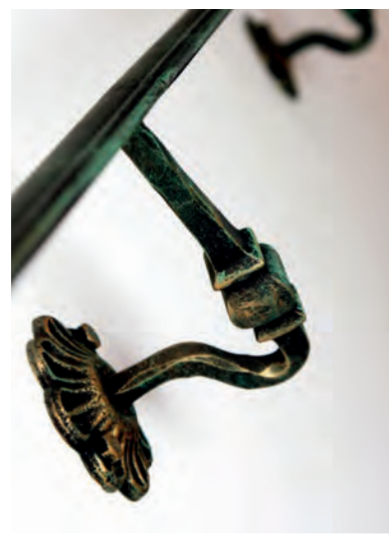

# AKCESORIA MOCUJĄCE

fixing elements / крепления / Befestigungszubehör



171



## Nakrętka kołpakowa

Nut / Винт колпачковый оцинкованный /  
Verschlusskappe verzinkt

	d	H	
<b>64.035</b>	M8	15	ocynk / galvanized
<b>64.036</b>	M10	18	ocynk / galvanized
<b>64.037</b>	M12	22	ocynk / galvanized



## Stalowy łącznik śrubowy

Screw connector / Стальной соединитель с резьбой /  
Gewindestange verzinkt

	d	L	
<b>64.040</b>	M8	1000	ocynk / galvanized
<b>64.041</b>	M10	1000	ocynk / galvanized
<b>64.042</b>	M12	1000	ocynk / galvanized
<b>64.043</b>	M14	1000	ocynk / galvanized
<b>64.044</b>	M16	1000	ocynk / galvanized





# SKRZYNKI NA LISTY

mail boxes  
ПОЧТОВЫЕ ЯЩИКИ  
Briefkästen



65.200 - 65.259

# SKRZYNKI NA LISTY

mail boxes / почтовые ящики / Briefkästen



	H	L	D			kolor / colour
<b>65.200</b>	405	255	90	A4	aluminium / stal	czarny / black
<b>65.202</b>	405	255	90	A4	aluminium / stal	miedz / copper
<b>65.203</b>	405	255	90	A4	aluminium / stal	grafit / graphite



	H	L	D			kolor / colour
<b>65.210</b>	435	385	180	A4	aluminium	czarny / black
<b>65.211</b>	435	385	180	A4	aluminium	miedz / copper



# SKRZYNKI NA LISTY

mail boxes / почтовые ящики / Briefkästen

175

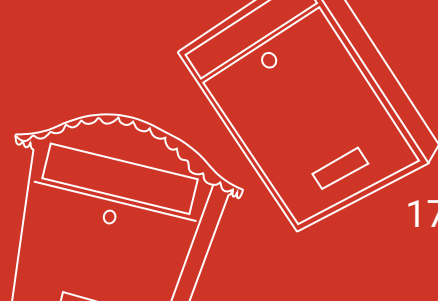

Skrzynka natynkowa  
Surface-mounted letter box / Почтовый ящик /  
Aufputzmontage Briefkasten

A4

	H	L	D		kolor
<b>N 65.212</b>	375	370	110	stal / steel	czarny / black



Skrzynka natynkowa  
Surface-mounted letter box / Почтовый ящик /  
Aufputzmontage Briefkasten

A4

	H	L	D		kolor
<b>N 65.213</b>	403	410	130	stal / steel	srebrny / silver



	H	L	D		kolor / colour
<b>65.250</b>	372	355	133	A4 stal	czarny / black



# SKRZYNKI NA LISTY

mail boxes / почтовые ящики / Briefkästen

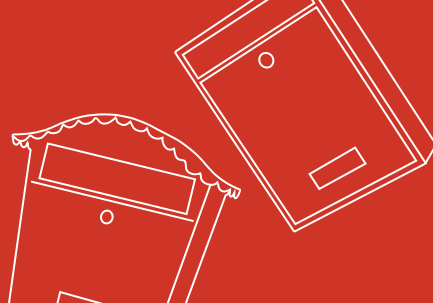

	H	L	D			kolor / colour
<b>65.257.01</b>	320	215	85	A4	stal	czarny / black



	H	L	D			kolor / colour
<b>65.259</b>	400	270	118	A4	stal	czarny / black



Sprawdź pełną gamę skrzynek na listy w katalogu  
Check the full range of mail boxes in the catalogue

**PSG**



# LAMPY

lamps / лампы / Lampen



177



	H	L	D	
<b>66.003.01</b>	670	310	420	ocynk / galvanized



	H	L	
<b>66.004.01</b>	400	300	ocynk / galvanized



	H	L	
<b>66.006.01</b>	380	290	ocynk / galvanized



# NOGI DO ŁAWEK

bench legs / ножки для скамеек / Bankfüße

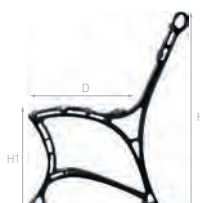

Noga aluminiowa do ławki  
Bench leg / Алюминиевая нога скамьи /  
Bankfuß

	H	H1	D
<b>66.050</b>	750	400	390

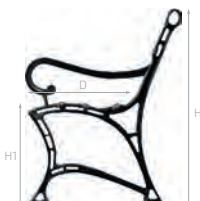

Noga aluminiowa do ławki z podłokietnikiem  
Bench leg with armrest / Алюминиевая нога скамьи с подлокотником /  
Bankfuß mit Armlehne

	H	H1	D
<b>66.051</b>	750	400	390

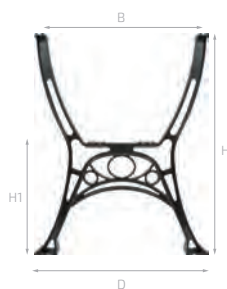

Noga aluminiowa do stołu  
Table leg / Алюминиевая нога стола /  
Tischbein Aluminium

	H	H1	D	B
<b>66.060</b>	690	365	580	465

# NOGI DO ŁAWEK

bench legs / ножки для скамеек / Bankfüße



179

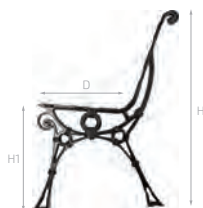

Noga aluminiowa do ławki  
Bench leg / Алюминиевая нога скамьи /  
Bankfuß

	H	H1	D
<b>66.052</b>	730	405	290

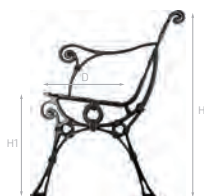

Noga aluminiowa do ławki z podłokietnikiem  
Bench leg with armrest / Алюминиевая нога скамьи с подлокотником /  
Bankfuß mit Armlehne

	H	H1	D
<b>66.053</b>	730	405	290



Noga stalowa do ławki  
Bench leg / Нога скамьи / Bankgestehl aus Stahl

	H	H1	D
<b>66.070</b>	840	440	460



Noga stalowa do stołu  
Table leg / Стальная нога скамьи / Tischgestehl aus Stahl

	H	D	B
<b>66.075</b>	745	740	800



# FARBY I PATYNY

paints and patinas  
краски и патины  
Farben und Patina

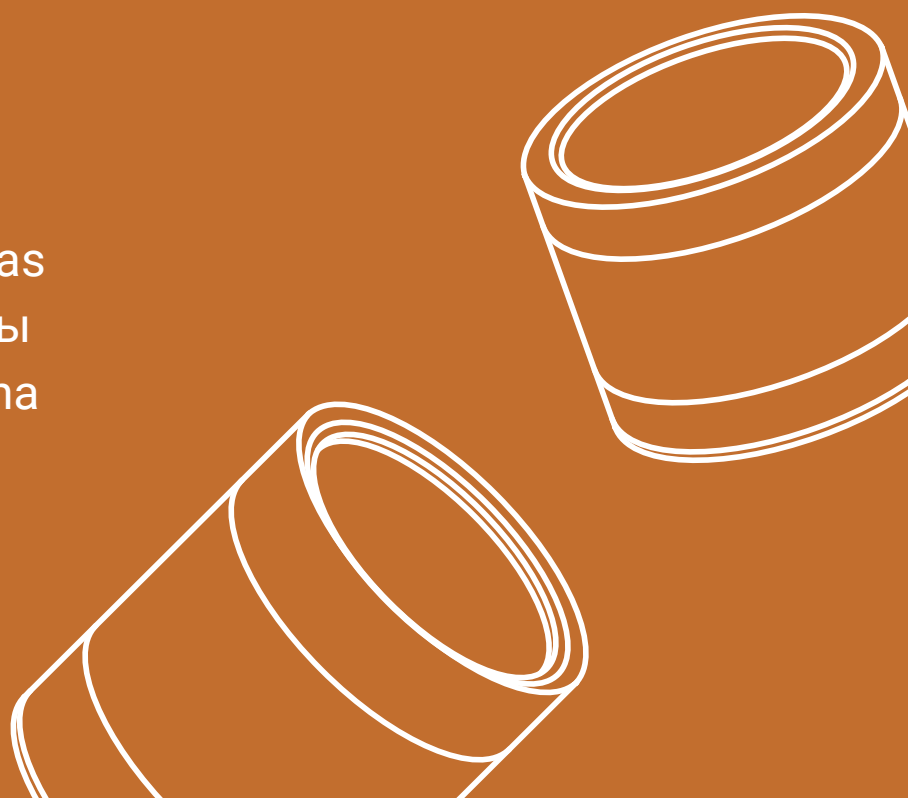

70.001 - 70.123

**PSG**



Farba podkładowa na metal czerwona  
Steel undercoat paint / Грунтовка по металлу / Stahlunterlack

	opakowanie packaging / упаковка / Verpackung	
<b>70.901</b>	1 l	czerwona red
<b>70.901.01</b>	3 l	
<b>70.901.02</b>	10 l	



Farba podkładowa na ocynk czerwona  
Galvanized undercoat paint /  
Грунтовка по металлу для оцинкованных поверхностей /  
Grundierung für verzinkten Stahl

	opakowanie packaging / упаковка / Verpackung	
<b>70.911</b>	1 l	czerwona red
<b>70.911.01</b>	3 l	
<b>70.911.02</b>	10 l	



Farba poliwinylowa  
Polyvinyl paint / Поливиниловая краска / Polyvinyl-Farbe

	opakowanie packaging / упаковка / Verpackung	
<b>70.001</b>	1 l	grafit antyczny graphite antique
<b>70.001.01</b>	3 l	
<b>70.001.02</b>	10 l	



Farba poliwinylowa  
Polyvinyl paint / Поливиниловая краска / Polyvinyl-Farbe

	opakowanie packaging / упаковка / Verpackung	
<b>70.002</b>	1 l	czarny antyczny black antique
<b>70.002.01</b>	3 l	
<b>70.002.02</b>	10 l	



Farba poliwinylowa  
Polyvinyl paint / Поливиниловая краска / Polyvinyl-Farbe

	opakowanie packaging / упаковка / Verpackung	
<b>70.003</b>	1 l	brąz antyczny antique bronze
<b>70.003.01</b>	3 l	

# FARBY I PATYNY

paints and patinas / краски и патины / Farben und Patina

183



Patyna poliwinylowa  
Polyvinyl patina / Поливиниловая патина / Polyvinyl Patina

opakowanie  
packaging /  
упаковка /  
Verpackung

70.101

0,23 l

patyna złoto  
patina gold



Patyna poliwinylowa  
Polyvinyl patina / Поливиниловая патина / Polyvinyl Patina

opakowanie  
packaging /  
упаковка /  
Verpackung

70.102

0,23 l

patyna srebro  
patina silver



Patyna poliwinylowa  
Polyvinyl patina / Поливиниловая патина / Polyvinyl Patina

opakowanie  
packaging /  
упаковка /  
Verpackung

70.103

0,23 l

patyna miedź  
patina copper



Patyna poliwinylowa  
Polyvinyl patina / Поливиниловая патина / Polyvinyl Patina

opakowanie  
packaging /  
упаковка /  
Verpackung

70.104

0,23 l

patyna zielona  
patina green



Patyna poliwinylowa  
Polyvinyl patina / Поливиниловая патина / Polyvinyl Patina

opakowanie  
packaging /  
упаковка /  
Verpackung

70.105

0,23 l

patyna jasnozielona  
patina bright green





Farba styrenowo - akrylowa  
Styrene-acrylic paint / Стирол - акриловая краска /  
Styrol-Acrylfarbe

	opakowanie packaging / упаковка / Verpackung	
<b>70.021</b>	1 l	grafit antyczny graphite antique
<b>70.021.01</b>	3 l	
<b>70.021.02</b>	10 l	



Farba styrenowo - akrylowa  
Styrene-acrylic paint / Стирол - акриловая краска /  
Styrol-Acrylfarbe

	opakowanie packaging / упаковка / Verpackung	
<b>70.022</b>	1 l	czarny antyczny black antique
<b>70.022.01</b>	3 l	
<b>70.022.02</b>	10 l	



Farba styrenowo - akrylowa  
Styrene-acrylic paint / Стирол - акриловая краска /  
Styrol-Acrylfarbe

	opakowanie packaging / упаковка / Verpackung	
<b>70.222</b>	1 l	czarny black
<b>70.222.01</b>	3 l	
<b>70.222.02</b>	10 l	



Farba styrenowo - akrylowa  
Styrene-acrylic paint / Стирол - акриловая краска /  
Styrol-Acrylfarbe

	opakowanie packaging / упаковка / Verpackung	
<b>70.321</b>	1 l	grafit - matowa graphite - mat
<b>70.321.01</b>	3 l	
<b>70.321.02</b>	10 l	

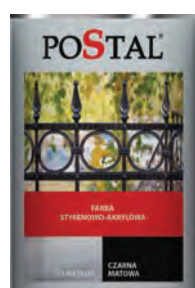

Farba styrenowo - akrylowa  
Styrene-acrylic paint / Стирол - акриловая краска /  
Styrol-Acrylfarbe

	opakowanie packaging / упаковка / Verpackung	
<b>70.322</b>	1 l	czarna - matowa black - mat
<b>70.322.01</b>	3 l	
<b>70.322.02</b>	10 l	

# FARBY I PATYNY

paints and patinas / краски и патины / Farben und Patina

185

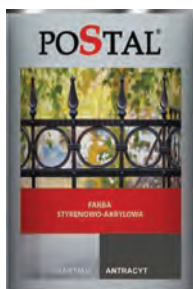

Farba styrenowo - akrylowa (strukturalna)  
Styrene-acrylic paint / Стирол - акриловая краска /  
Styrol-Acrylfarbe

opakowanie  
packaging /  
упаковка /  
Verpackung

70.323  
70.323.01

1 l  
3 l

antracyt - półmat  
anthracite - half-matt



Patyna styrenowo-akrylowa  
styrene-acrylic patina / стирол - акриловая патина /  
Styrol-Acryl-Patina

opakowanie  
packaging /  
упаковка /  
Verpackung

70.121

0,23 l

patyna złoto  
patina gold



Patyna styrenowo-akrylowa  
styrene-acrylic patina / стирол - акриловая патина /  
Styrol-Acryl-Patina

opakowanie  
packaging /  
упаковка /  
Verpackung

70.122

0,23 l

patyna srebro  
patina silver



Patyna styrenowo-akrylowa  
styrene-acrylic patina / стирол - акриловая патина /  
Styrol-Acryl-Patina

opakowanie  
packaging /  
упаковка /  
Verpackung

70.123

0,23 l

patyna miedź  
patina copper



# KOTWY I AKCESORIA

anchors and accessories / химические анкера / Anker und Zubehör



Kotwy chemiczne  
Chemical anchors / Химические анкера / Chemische Anker

		aprobata techniczna technical approval / техническое одобрение / technische Zulassung	opakowanie packaging / упаковка / Verpackung
<b>71.300</b>	letnia summer / летняя / Sommer	ITB - KOT	300 ml
<b>71.410</b>	letnia summer / летняя / Sommer	ITB - KOT	410 ml
<b>71.410.01</b>	zimowa winter / зимняя / Winter	ITB - KOT	410 ml
<b>71.410.02</b>	do stali nierdzewnej for stainless steel / к нержавеющей стали / für Edelstahl	ETA	410 ml



Mieszacz do kotwy chemicznej  
Mixer for chemical anchor /  
Насадка-миксер сменная для химического анкера / Mischer für chemische anker

	opakowanie packaging / упаковка / Verpackung
<b>71.001</b>	4 szt.



Tuleja siatkowa  
Perforated sleeves / Втулка сеточная / Perforierte Buchse

	wymiary dimensions / Параметры / Abmessungen
<b>74.012</b>	∅ 12 x 50
<b>74.015</b>	∅ 15 x 85
<b>74.015.01</b>	∅ 15 x 130
<b>74.020</b>	∅ 20 x 85

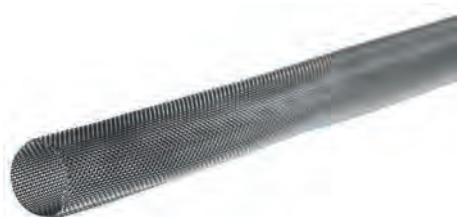

Tuleja siatkowa stalowa  
Metal-mesh sleeves / Втулка сеточная / Perforierte Buchse

	wymiary dimensions / Параметры / Abmessungen
<b>74.112</b>	∅ 12 x 1000
<b>74.115</b>	∅ 16 x 1000



Wycior do czyszczenia otworów  
Hole cleaning rod / Щетки для очистки отверстий / Lochwischer

	wymiary dimensions / Параметры / Abmessungen
<b>75.010</b>	∅ 10
<b>75.013</b>	∅ 13
<b>75.018</b>	∅ 18

# KOTWY I AKCESORIA

anchors and accessories / химические анкера / Anker und Zubehör

187



Pompka do wydmuchiwania zwiercin  
Blowing machine pump / Насос для продувки отверстий / Bohrlochpumpe

**75.025**



Wyciskacz profesjonalny  
Professional squeezer / Пистолет для выпрессовывания картриджей / Auspresspistole

**75.030**

300 ml



Wyciskacz profesjonalny  
Professional squeezer / Пистолет для выпрессовывания картриджей / Auspresspistole

**75.041**

380 ml / 410 ml



Wyciskacz profesjonalny  
Professional squeezer / Пистолет для выпрессовывания картриджей / Auspresspistole

**75.041.01**

380 ml / 410 ml



Platinum

STAR WIRE

STAR WIRE  
STAR WIRE

STAR WIRE



DRUT SPAWALNICZY • SCHWEIBDRAHT • SVAŘOVACÍ DRÁT • СВАРОЧНАЯ ПРОВОДКА

# DRUT I AKCESORIA SPAWALNICZE

welding wire and accessories  
сварочная проволока и принадлежности  
Schweißdraht und Schweißzubehör

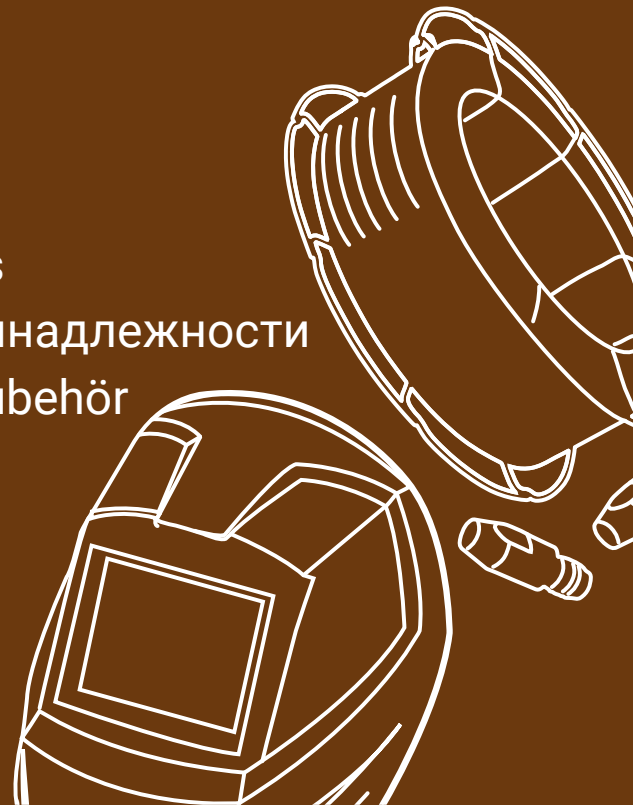

SP.001.08 - SWM.UCHWYT.01

Platinum

STAR  
WIRE 

POSTAL<sup>®</sup>

# DRUT I AKCESORIA SPAWALNICZE

welding wire and accessories / сварочная проволока и принадлежности /  
Schweißdraht und Schweißzubehör

190

Platinum



Drut spawalniczy MIG MAG

MIG MAG welding wire / Сварочная проволока MIG MAG / Schweißdraht MIG MAG

	rodzaj kind вид Sorte	grubość thickness толщина Stärke	opakowanie packaging упаковка Verpackung	szpula spool шпуля Drahtspule	ilość na palecie quantity per pallet количество на палете Stückzahl pro Palette
<b>SP.001.08</b>	G3Si1/SG2	0,8	15 kg	metal	72
<b>SP.002.10</b>	G3Si1/SG2	1,0	15 kg	metal	72
<b>SP.003.12</b>	G3Si1/SG2	1,2	15 kg	metal	72

Platinum



Drut spawalniczy MIG MAG

MIG MAG welding wire / Сварочная проволока MIG MAG / Schweißdraht MIG MAG

	rodzaj kind вид Sorte	grubość thickness толщина Stärke	opakowanie packaging упаковка Verpackung	szpula spool шпуля Drahtspule	ilość na palecie quantity per pallet количество на палете Stückzahl pro Palette
<b>SP.010.12</b>	G4Si1/SG3	1,2	15 kg	metal	72



Drut jest zgodny z normą G3Si1, DIN EN ISO 14341-A, SFA/AWS 5.18:ER70S-6 posiada atesty TUV, DB42.142.01, ABS, LR.

The wire is compliant G3Si1, DIN EN ISO 14341-A, SFA/AWS 5.18:ER70S-6 is certified by TUV, DB42.142.01, ABS, LR.

Проволока соответствует нормам G3Si1, DIN EN ISO 14341-A, SFA/AWS 5.18:ER70S-6 аттестована TUV, DB42.142.01, ABS, LR.

Der Schweißdraht entspricht den Normen G3Si1, DIN EN ISO 14341-A, SFA/AWS 5.18:ER70S-6 ist zertifiziert TUV, DB42.142.01, ABS, LR.

# DRUT I AKCESORIA SPAWALNICZE

welding wire and accessories / сварочная проволока и принадлежности /  
Schweißdraht und Schweißzubehör

191



## Drut spawalniczy MIG MAG

MIG MAG welding wire / Сварочная проволока MIG MAG / Schweißdraht MIG MAG

	rodzaj kind вид Sorte	grubość thickness толщина Stärke	opakowanie packaging упаковка Verpackung	szpula spool шпуля Drahtspule	ilość na palecie quantity per pallet количество на палете Stückzahl pro Palette
<b>SP.001.08X</b>	G3Si1/SG2	0,8	15 kg	metal	72
<b>SP.002.10X</b>	G3Si1/SG2	1,0	15 kg	metal	72
<b>SP.003.12X</b>	G3Si1/SG2	1,2	15 kg	metal	72



## Drut spawalniczy MIG MAG

MIG MAG welding wire / Сварочная проволока MIG MAG / Schweißdraht MIG MAG

	rodzaj kind вид Sorte	grubość thickness толщина Stärke	opakowanie packaging упаковка Verpackung	szpula spool шпуля Drahtspule	ilość na palecie quantity per pallet количество на палете Stückzahl pro Palette
<b>SP.004.08X</b>	G3Si1/SG2	0,8	5 kg	plastik	200
<b>SP.005.10X</b>	G3Si1/SG2	1,0	5 kg	plastik	200



## Drut spawalniczy MIG MAG

MIG MAG welding wire / Сварочная проволока MIG MAG / Schweißdraht MIG MAG

	rodzaj kind вид Sorte	grubość thickness толщина Stärke	opakowanie packaging упаковка Verpackung	szpula spool шпуля Drahtspule	ilość na palecie quantity per pallet количество на палете Stückzahl pro Palette
<b>SP.011.10X</b>	G4Si1/SG3	1,0	15 kg	metal	72



## Drut proszkowy

Flux-cored welding wire / Порошковая проволока / Fülldraht

	rodzaj kind вид Sorte	grubość thickness толщина Stärke	opakowanie packaging упаковка Verpackung	szpula spool шпуля Drahtspule	ilość na palecie quantity per pallet количество на палете Stückzahl pro Palette
<b>SPP.003.12X</b>	E71T-1C H8	1,2	15 kg	plastik	72

# DRUT I AKCESORIA SPAWALNICZE

welding wire and accessories / сварочная проволока и принадлежности /  
Schweißdraht und Schweißzubehör



Sprężyna dyszy

Nozzle spring / Пружина сопла / Haltefeder

**SPA.002.0058**

15 AK

**SPA.003.0013**

25AK



Łącznik dyszy gazowej / łącznik prądowy

Tip holder with spring / Current connector /

Держатель газового сопла / Вставка для наконечника /  
Gasdüsenträger / Stromdüsenträger /

**SPA.002.0078 L**

M6/M8 x 1

15 AK

lewy



Łącznik dyszy gazowej / łącznik prądowy

Tip holder with spring / Current connector /

Держатель газового сопла / Вставка для наконечника /  
Gasdüsenträger / Stromdüsenträger /

**SPA.142.0001**

M6/M8

25 AK

lewy



Łącznik prądowy

Current connector / Вставка для наконечника / Stromdüsenträger

**SPA.142.0003**

M6

24 KD



Łącznik prądowy

Current connector / Вставка для наконечника / Stromdüsenträger

**SPA.142.0020**

M8

36 KD



Łącznik prądowy

Current connector / Вставка для наконечника / Stromdüsenträger

**SPA.142.0022**

M8

401D/501D

# DRUT I AKCESORIA SPAWALNICZE

welding wire and accessories / сварочная проволока и принадлежности /  
Schweißdraht und Schweißzubehör

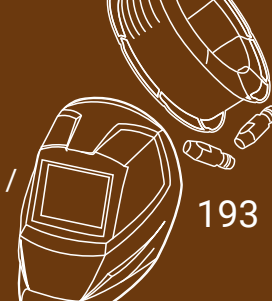

193

32,5



Rozdzielacz gazu

Gas diffuser / Диффузор газовый / Gasverteiler

**SPA.012.0183**

24 KD

standardowy

**SPA.014.0023**

36 KD

ceramiczny

28



Rozdzielacz gazu

Gas diffuser / Диффузор газовый / Gasverteiler

**SPA.030.0145**

401 D/501D

standardowy



Dysze gazowe

Gas nozzle / Газовое сопло / Gasdüsen

**SPA.145.0075**

15 AK

ø 12

stożkowa



Dysze gazowe

Gas nozzle / Газовое сопло / Gasdüsen

**SPA.145.0076**

25 AK

ø 15

stożkowa



Dysze gazowe

Gas nozzle / Газовое сопло / Gasdüsen

**SPA.145.0080**

24 KD

ø 12,5

stożkowa

**SPA.145.0078**

36 KD

ø 16

stożkowa



Dysze gazowe

Gas nozzle / Газовое сопло / Gasdüsen

**SPA.145.0085**

401 D / 501 D

ø 16

stożkowa

# DRUT I AKCESORIA SPAWALNICZE

welding wire and accessories / сварочная проволока и принадлежности /  
Schweißdraht und Schweißzubehör

194



## Dysze prądowe

Contact tip / Токопроводящие наконечники / Stromdüsen

<b>SPA.140.0008</b>	15 AK	∅ 0,6	M6x25	E-Cu
<b>SPA.140.0059</b>	15 AK	∅ 0,8	M6x25	E-Cu
<b>SPA.140.0253</b>	15 AK	∅ 1,0	M6x25	E-Cu
<b>SPA.140.0387</b>	15 AK	∅ 1,2	M6x25	E-Cu



## Dysze prądowe

Contact tip / Токопроводящие наконечники / Stromdüsen

<b>SPA.140.0051</b>	25 AK	∅ 0,8	M6x28	E-Cu
<b>SPA.140.0054</b>	25 AK	∅ 0,8	M6x28	CuCrZr
<b>SPA.140.0242</b>	25 AK	∅ 1,0	M6x28	E-Cu
<b>SPA.140.0245</b>	25 AK	∅ 1,0	M6x28	CuCrZr
<b>SPA.140.0379</b>	25 AK	∅ 1,2	M6x28	E-Cu
<b>SPA.140.0382</b>	25 AK	∅ 1,2	M6x28	CuCrZr



## Dysze prądowe

Contact tip / Токопроводящие наконечники / Stromdüsen

<b>SPA.140.0114</b>	36 KD	∅ 0,8	M8x30	E-Cu
<b>SPA.140.0313</b>	36 KD	∅ 1,0	M8x30	E-Cu
<b>SPA.140.0442</b>	36 KD	∅ 1,2	M8x30	E-Cu
<b>SPA.140.0445</b>	36 KD	∅ 1,2	M8x30	CuCrZr
<b>SPA.140.0587</b>	36 KD	∅ 1,6	M8x30	E-Cu
<b>SPA.140.0590</b>	36 KD	∅ 1,6	M8x30	CuCrZr
<b>SPA.141.0015</b>	36 KD	∅ 1,2	M8x30	E-Cu do Al



# DRUT I AKCESORIA SPAWALNICZE

welding wire and accessories / сварочная проволока и принадлежности /  
Schweißdraht und Schweißzubehör

195

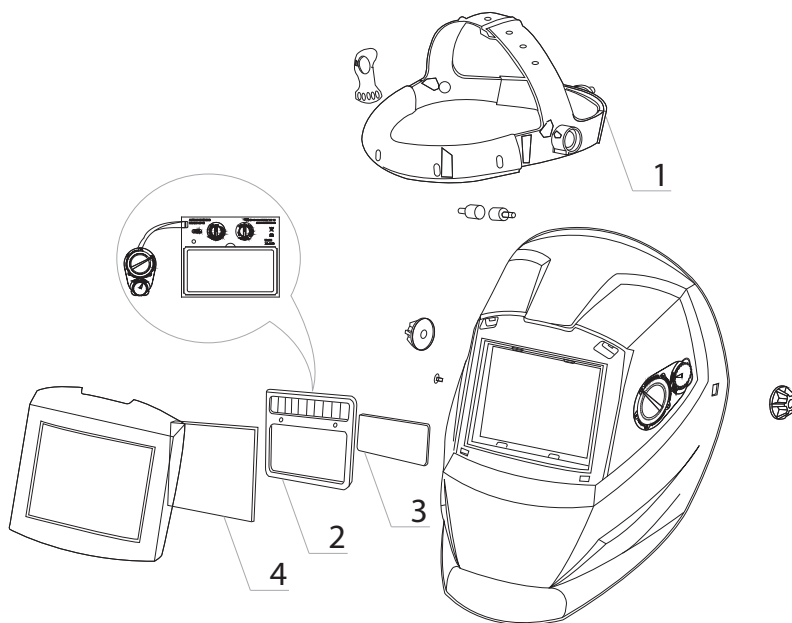

## Przyłbica automatyczna Star Wire 1/1/1/2 wg normy EN 379

Automatic welding helmet Star Wire 1/1/1/2 according to EN 379 /

Автоматическая сварочная маска согласно норме EN 379 /

automatic Schweißerschutzhelm Star Wire 1/1/1/2 nach der Norm EN 379

### Klasa optyczna (dokładność widzenia)

Optical class

bardzo dobra (klasa 1)

very good (class 1)

### Rozproszenie światła

Diffusion of light class

bardzo dobra (klasa 1)

very good (class 1)

### Różnice w przepuszczalności światła (jasne lub ciemne obszary w polu widoku)

Variation of luminous transmittance class

bardzo dobra (klasa 1)

very good (class 1)

### Zależność kąta na przepuszczalność światła

Angle dependence of luminous transmittance class

dobra (klasa 2)

good (class 2)

Przyłbica automatyczna

Automatic welding helmet / Автоматическая сварочная маска / Automatischer Schweißerschutzhelm

## SWM.PRZYŁBICA.01

### Przyłbica Star-Wire z systemem ADF

Welding helmet with ADF filter / Сварочная маска с фильтром ADF / Schweißhelm mit ADF Filter

Akcesoria do przyłbicy automatycznej

Accessories for automatic welding helmet / Аксессуары для автоматической сварочной маски / Zubehörteile für automatischen Schweißerschutzhelm

### 1 SWM.UCHWYT.01

#### Uchwyt przyłbicy Star-Wire

Headgear / Оголовье маски Star-Wire / Kopfbedeckung

### 2 SWM.ADF.01

#### Filtr ADF

Filter ADF / Фильтр ADF / Automatikfilter

### 3 SWM.INNER.01

#### Wewnętrzne soczewki ochronne 104.7\*53.8\*1mm

Inner protection lens 104.7\*53.8\*1mm / Внутренние защитные линзы 104.7\*53.8\*1мм / Innere Schutzkassette 104.7\*53.8\*1mm

### 4 SWM.OUTER.01

#### Zewnętrzne soczewki ochronne 110\*90\*1mm

Outer protection lens 110\*90\*1mm / Внешние защитные линзы 110\*90\*1мм / Äußere Schutzkassette 110\*90\*1mm

cutting steel, InOX-stainless

STAR FLEX



### Tarcza do cięcia stali

Cutting disc / Диск для резки / Trennscheibe



	wymiary dimensions / Параметры / Abmessungen	opakowanie packaging / упаковка / Verpackung
TCI 115 10 22	115 x 1,0 x 22	50
TCI 125 10 22	125 x 1,0 x 22	50
TCI 125 16 22	125 x 1,6 x 22	50
TCI 125 25 22	125 x 2,5 x 22	50
TCI 230 20 22	230 x 2,0 x 22	50
TCI 230 30 22	230 x 3,0 x 22	25
TCI 300 30 32	300 x 3,0 x 32	25
TCI 350 35 32	350 x 3,5 x 32	25
TCI 400 40 32	400 x 4,0 x 32	25



# TARCZE

discs / диски / Trennscheiben

197

STAR FLEX



## Tarcza zdzierna

Grinding disc / Абразивный диск / Schruppscheibe



	wymiary dimensions / Параметры / Abmessungen	opakowanie packaging / упаковка / Verpackung
<b>TZI 125 60 22</b>	125 x 6,0 x 22	25
<b>TZI 230 60 22</b>	230 x 6,0 x 22	10

STAR FLEX

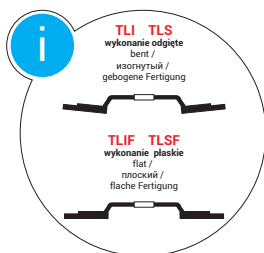

## Tarcza listkowa do szlifowania

Flap disc / Лепестковый диск для шлифовки стали / Lamellenschleifscheibe

	wymiary dimensions / Параметры / Abmessungen	opakowanie packaging / упаковка / Verpackung
<b>TLI 125 22 40</b>	125 x 22 x 40	10
<b>TLI 125 22 60</b>	125 x 22 x 60	10
<b>TLI 125 22 80</b>	125 x 22 x 80	10
<b>TLI 125 22 100</b>	125 x 22 x 100	10
<b>TLI 125 22 120</b>	125 x 22 x 120	10
<b>TLIF 125 22 40</b>	125 x 22 x 40	10
<b>TLS 125 22 40</b>	125 x 22 x 40	10
<b>TLS 125 22 60</b>	125 x 22 x 60	10
<b>TLS 125 22 80</b>	125 x 22 x 80	10
<b>TLS 125 22 100</b>	125 x 22 x 100	10
<b>TLS 125 22 120</b>	125 x 22 x 120	10
<b>TLSF 125 22 40</b>	125 x 22 x 40	10



## Tarcza listkowa ceramiczna

Ceramic flap disc / Керамический лепестковый диск /  
Lamellenschleifscheibe Keramik



	wymiary dimensions / Параметры / Abmessungen	opakowanie packaging / упаковка / Verpackung
<b>TLC 125 22 40</b>	125 x 22 x 40	10
<b>TLC 125 22 60</b>	125 x 22 x 60	10
<b>TLC 125 22 80</b>	125 x 22 x 80	10



## Tarcza listkowa pachwinowa

do szlifowania stali czarnej i stali nierdzewnej  
Zircon curve flap discs / Круг лепестковый для обработки  
сварочных швов / Zircon Gebogene Schleiflamellenteller



	wymiary dimensions / Параметры / Abmessungen	opakowanie packaging / упаковка / Verpackung
<b>TLP 125 22 40</b>	125 x 22 x 40	10
<b>TLP 125 22 60</b>	125 x 22 x 60	10
<b>TLP 125 22 80</b>	125 x 22 x 80	10

kod	strona	kod	strona	kod	strona	kod	strona	kod	strona
<b>1xxxx</b>		10.300	15	12.148	21	13.071	32	20.013	44
10.089	12	10.301	15	12.150	21	13.072	32	20.020	44
10.090	12	10.302	15	13.000	24	13.073	32	20.100	45
10.091	12	10.303	15	13.003	24	13.074	32	20.102	45
10.092	12	10.304	15	13.005	24	13.081	34	20.105	45
10.093	12	10.305	15	13.006	24	13.082	34	20.130	45
10.094	12	10.310	15	13.006.01	24	13.090	33	20.148	45
10.095	12	10.311	15	13.007	24	13.091	33	20.149	45
10.096	12	10.312	15	13.008	24	13.092	33	21.010	45
10.097	12	10.313	15	13.009	25	13.093	33	21.011	45
10.098	12	10.315	16	13.010	25	13.094	33	21.024	45
10.099	12	10.316	16	13.011	25	13.096	33	21.025	45
10.100	12	10.317	16	13.012	25	13.097	33	21.116	45
10.101	12	10.320	16	13.013	26	13.100	34	21.117	45
10.102	12	10.321	16	13.013.01	26	13.101	34	21.118	46
10.103	12	10.323	16	13.015	26	13.104	35	21.119	46
10.104	12	10.328	16	13.016	26	13.105	35	21.120	46
10.107	12	10.330	16	13.017	26	13.106	35	21.122	46
10.108	12	10.340	16	13.018	27	13.107	35	21.124	46
10.109	12	11.030	17	13.018.01	27	13.111	36	21.140	46
10.116	12	11.031	17	13.018.02	27	13.112	36	21.141	46
10.125	12	11.032	17	13.020	27	13.113	36	21.145	46
10.130	12	11.041	17	13.023	27	13.190	36	21.147	46
10.200	13	11.042	17	13.025	27	13.191	36	21.900	47
10.201	13	11.051	17	13.026	28	13.192	37	21.901	47
10.202	13	11.052	17	13.028	28	13.198	37	21.902	47
10.203	13	11.061	17	13.029	28	13.200	38	22.001	47
10.204	13	11.062	17	13.030	28	13.202	38	22.002	47
10.205	13	11.091	17	13.032	29	13.203	38	22.003	47
10.206	13	11.231	17	13.033	29	13.204	38	22.004	47
10.207	13	11.232	17	13.034	29	13.209	39	22.005	47
10.208	13	11.241	17	13.035	29	13.210	39	22.013	47
10.209	13	11.242	17	13.037	29	13.241	40	22.019	47
10.210	13	11.331	17	13.038	29	13.248	40	22.020	47
10.211	13	11.332	17	13.040	29	13.249	40	22.021	48
10.215	14	12.010	20	13.041	29	13.250	40	22.022	48
10.216	14	12.080	20	13.042	30	13.251	40	22.053	48
10.220	14	12.081	20	13.045	30	13.252	40	22.100	48
10.221	14	12.082	20	13.046	30	13.253	40	22.103	48
10.224	14	12.083	20	13.048	30	13.256	40	22.104	48
10.226	14	12.084	20	13.056	30	13.315	40	22.105	48
10.230	14	12.111	20	13.057	30	13.323	40	22.107	48
10.231	14	12.112	20	13.058	31	<b>2xxxx</b>		22.150	49
10.240	14	12.113	20	13.059	31	20.001	44	22.151	49
10.241	14	12.115	21	13.060	31	20.003	44	22.200	49
10.242	14	12.118	21	13.061	31	20.010	44	22.201	49
10.243	14	12.124	21	13.067	31	20.010.01	44	22.203	49
10.250	14	12.130	21	13.068	31	20.011	44	22.204	49
10.251	14	12.131	21	13.070	32	20.012	44	22.205	49

kod	strona	kod	strona	kod	strona	kod	strona	kod	strona
22.206	49	30.010	57	31.350	61	34.017	68	40.066	74
22.207	49	30.010.01	57	31.350.12	61	34.020	68	40.067	74
22.208	49	30.020	64	31.350.24	61	34.020.00	68	40.068	74
22.209	49	30.020.01	64	31.350M1	61	34.023	68	40.071	75
23.001	50	30.020.02	64	31.400	61	34.023.00	68	40.071.01	75
23.002	50	30.021	64	31.400.12	61	34.102	69	40.072	75
23.003	50	30.021.01	64	31.400.24	61	34.102.00	69	40.072.01	75
23.004	50	30.021.02	64	31.400M1	61	34.105	69	40.073	75
23.005	50	30.022	64	31.402	61	34.105.00	69	40.077	75
23.006	50	30.022.01	64	31.402M1	61	34.107	69	40.077.02	75
23.007	50	30.022.02	64	31.403	61	34.107.00	69	40.078	75
23.008	50	30.030	64	31.403M1	61	34.111	69	40.078.01	75
23.009	50	30.031	64	31.404	61	34.111.00	69	40.078.02	75
23.010	50	30.032	64	31.404M1	61	34.120	69	40.080	75
23.015	50	30.100	57	32.001	65	34.120.00	69	40.081	75
23.020	50	30.101	57	32.001.00	65	34.221	69	40.083	75
23.021	50	30.101.00	57	32.003	65	34.230	69	40.088.01	76
23.024	51	30.102	57	32.003.00	65	34.231	69	40.089	76
23.025	51	30.102.00	57	32.005	65	4xxxx		40.092	76
23.030	51	30.103	58	32.005.00	65	40.001	72	40.092.01	76
23.031	51	30.103.01	58	32.007	65	40.002	72	40.093	76
23.065	51	30.105	58	32.100	65	40.003	72	40.095	76
24.011	52	30.105.00	58	32.101	65	40.006	72	40.096	76
24.111	52	30.105.01	58	32.111	66	40.007	72	40.097	76
24.112	52	30.105.02	58	32.112	66	40.008	72	40.097.30	76
24.151	52	30.111	59	32.113	66	40.011	72	40.098.01	76
24.254	52	30.111.00	59	32.114	66	40.012	72	40.098.02	76
24.255	52	30.111.01	59	32.115	66	40.013	72	40.098.03	76
24.257	52	30.113	58	32.117	66	40.017	72	40.099.01	76
24.259	52	30.113.01	58	32.200	66	40.018	72	40.099.02	76
24.266	52	30.113.04	58	32.201	66	40.041	73	40.099.03	76
3xxxx		30.114	59	32.202	66	40.045	73	40.099.04	76
30.001	56	30.114.01	59	33.000	67	40.048	73	40.100	76
30.001.00	56	30.115	60	33.001	67	40.048.01	73	40.102	77
30.001.01	56	30.123	58	33.013	67	40.049	73	40.102.01	77
30.001.04	56	30.125	60	33.023	67	40.050	73	40.104	77
30.002	56	30.200	60	33.098	67	40.052	73	40.106	77
30.002.00	56	30.202	60	33.099	67	40.052.02	73	40.110	77
30.002.01	56	30.220	60	33.100	67	40.052.03	73	40.111	77
30.002.02	56	31.101	60	33.201	67	40.053	73	40.112	77
30.002.03	56	31.101.00	60	34.000	68	40.055	73	40.112.01	77
30.003	56	31.102	60	34.002	68	40.056	73	40.117	77
30.003.00	56	31.102.00	60	34.002.00	68	40.058	74	40.118	77
30.003.01	56	31.103	60	34.005	68	40.059	74	40.123	77
30.003.02	56	31.103.00	60	34.008	68	40.060	74	40.125	77
30.003.03	56	31.300.01	61	34.008.00	68	40.060.01	74	40.126	78
30.003.04	56	31.300.01M1	61	34.011	68	40.060.02	74	40.133	78
30.008	57	31.300.12	61	34.011.00	68	40.061	74	40.140	78
30.008.00	57	31.300.24	61	34.014	68	40.065	74	40.150	78

kod	strona	kod	strona	kod	strona	kod	strona	kod	strona
40.151	78	41.307	85	43.506	92	44.053	98	44.206	101
40.153	78	41.315	85	43.507	92	44.054	98	44.220	101
40.154	78	41.316	85	43.508	92	44.060	101	44.230.ZN	100
40.155	78	41.317	85	43.510	92	44.119	98	44.231.ZN	100
40.156	78	41.318	85	43.512	92	44.121	98	44.232.ZN	100
40.157	78	41.400	86	43.515	92	44.122	98	44.233.ZN	100
40.159	78	41.401	86	43.615	93	44.123	98	44.234.ZN	100
40.162	79	41.402	86	43.620	93	44.126	98	44.235.ZN	100
40.170	79	41.403	86	43.625	93	44.127	98	44.236.ZN	100
40.182	79	41.407	86	43.630	93	44.128	98	44.237.ZN	100
40.183	79	41.408	86	43.635	93	44.129	98	44.238.ZN	100
40.200	79	41.409	86	43.640	93	44.134	99	44.239.ZN	100
40.202	79	41.501	87	43.650	93	44.136	99	44.240.ZN	100
40.210	79	41.502	87	43.660	93	44.138	99	44.241.ZN	100
40.211	79	41.503	87	43.660.01	93	44.139	99	44.242.ZN	100
40.300	79	41.504	87	43.670	93	44.140	99	44.243.ZN	100
41.001	82	41.505	87	43.680	93	44.141	99	44.244.ZN	100
41.002	82	41.506	87	43.680.01	93	44.142	99	44.246.ZN	100
41.002.01	82	42.000	90	43.690	93	44.143	99	44.247.ZN	100
41.003	82	42.001	90	43.700	93	44.144	99	44.248.ZN	100
41.004	82	42.003	90	43.700.01	93	44.145	99	44.249.ZN	100
41.005	82	42.004	90	43.720	93	44.146	99	44.251.ZN	100
41.006	82	42.005	90	43.720.01	93	44.146.ZN	99	44.252.ZN	100
41.007	82	42.005.01	90	43.750	93	44.147	99	44.254.ZN	100
41.008	82	42.006	90	43.800.01	93	44.147.ZN	99	44.256.ZN	100
41.011	82	42.007	90	44.001	96	44.148	99	44.257.ZN	100
41.012	82	42.008	90	44.004	96	44.148.ZN	99	44.258.ZN	100
41.021	83	42.011	91	44.006	96	44.149	99	44.259.ZN	100
41.022	83	42.012	91	44.010	96	44.149.ZN	99	5xxxx	
41.023	83	42.013	91	44.011	96	44.150	99	50.000	104
41.024	83	42.030	91	44.013	96	44.150.ZN	99	50.001	104
41.025	83	43.015	92	44.017	96	44.151	99	50.003	104
41.026	83	43.020	92	44.018	96	44.151.ZN	99	50.004	104
41.050	83	43.025	92	44.020	96	44.152	99	50.005	104
41.060	83	43.030	92	44.026	97	44.152.ZN	99	50.006	104
41.070	83	43.035	92	44.029	97	44.153	99	50.009	104
41.102	84	43.040	92	44.034	97	44.154	99	50.010	104
41.104	84	43.050	92	44.036	97	44.155	99	50.011	104
41.105	84	43.120	92	44.038	97	44.155.ZN	99	50.012	104
41.106	84	43.125	92	44.039	97	44.156	99	50.014	104
41.111	84	43.130	92	44.040	97	44.157	100	50.021	104
41.114	84	43.135	92	44.043	97	44.158	100	50.021.01	104
41.115	84	43.140	92	44.046	98	44.159	100	50.022	104
41.202	84	43.150	92	44.047	98	44.200	101	50.023	104
41.204	84	43.230	92	44.048	98	44.201	101	50.024	104
41.205	84	43.240	92	44.049	98	44.202	101	50.025	104
41.206	84	43.250	92	44.050	98	44.203	101	50.029	105
41.207	84	43.504	92	44.051	98	44.204	101	50.030	105
41.306	85	43.505	92	44.052	98	44.205	101	50.031	105

kod	strona	kod	strona	kod	strona	kod	strona	kod	strona
50.042	105	50.176	39, 109	51.073	114	51.252	119	52.216	127
50.043	105	50.182	109	51.074	114	51.253	120	52.217	127
50.051	105	50.183	109	51.077	114	51.254	120	52.300	128
50.054	105	50.188	110	51.078	114	51.418	120	52.301	128
50.055	105	50.189	110	51.079	115	51.427	120	52.305	128
50.056	105	50.190	110	51.080	115	51.449	120	52.406	128
50.062	106	50.195	110	51.082	115	51.451	120	52.420	128
50.063	106	50.196	110	51.083	115	51.452	120	53.000	128
50.064	106	50.197	110	51.097	115	52.003	124	53.008	128
50.095	106	50.200	110	51.098	115	52.004	124	53.009	128
50.096	106	50.201	110	51.099	115	52.005	124	55.001	129
50.097	106	50.210	110	51.101	115	52.006	124	55.003	129
50.100	106	50.211	111	51.102	115	52.009	124	55.005	129
50.101	106	50.212	111	51.103	115	52.010	124	55.006	129
50.102	106	50.213	111	51.104	115	52.011	124	55.007	129
50.103	106	50.216	111	51.105	115	52.012	124	55.008	129
50.104	107	50.217	111	51.106	116	52.013	124	55.009	129
50.105	107	50.218	111	51.107	116	52.014	124	55.030	130
50.106	107	50.219	111	51.108	116	52.015	124	55.031	130
50.107	107	50.229	112	51.108.01	116	52.016	124	55.050	131
50.108	107	50.230	112	51.110	116	52.017	125	55.100	131
50.109	107	50.236	112	51.113	116	52.018	125	55.101	131
50.110	107	50.237	112	51.114	116	52.019	125	55.102	131
50.111	107	50.238	112	51.115	116	52.020	125	55.103	131
50.112	107	50.239	112	51.116	116	52.021	125	55.104	131
50.122	107	50.240	112	51.121	117	52.022	125	55.105	131
50.124	107	50.241	112	51.122	117	52.023	125	55.200	131
50.133	108	50.242	112	51.123	117	52.024	125	56.010.12	134
50.134	108	50.243	112	51.124	117	52.025	125	56.010.12.01	134
50.136	108	50.244	113	51.125	117	52.026	125	56.020.12	134
50.138	108	50.245	113	51.126	117	52.029	125	56.020.12.01	134
50.143	108	50.255	113	51.127	117	52.030	125	56.030.12	134
50.143.01	108	50.256	113	51.128	117	52.034	126	56.040.12	134
50.143.02	108	50.257	113	51.129	118	52.043.01	126	56.040.12.01	134
50.150	108	50.258	113	51.130	118	52.044	126	56.050.12	135
50.151	108	51.003	114	51.133	118	52.047	126	56.050.12.01	135
50.152	108	51.004	114	51.134	118	52.049	126	56.060.12	135
50.153	108	51.015	114	51.140	118	52.050	126	56.060.12.01	135
50.154	108	51.016	114	51.143	118	52.130	126	56.070.12	135
50.156	109	51.017	114	51.144	118	52.131	126	56.070.12.01	135
50.157	109	51.018	114	51.145	118	52.132	126	56.080.12	135
50.158	109	51.059	114	51.147	118	52.133	126	56.080.12.01	135
50.159	109	51.060	114	51.153	119	52.134	126	56.090.12	135
50.160	109	51.061	114	51.154	119	52.139	126	56.090.12.01	135
50.161	109	51.062	114	51.235	119	52.201	127	6xxxx	
50.162	109	51.063	114	51.236	119	52.202	127	61.100	140
50.165	109	51.064	114	51.240	119	52.203	127	61.101	140
50.166	109	51.069	114	51.241	119	52.211	127	61.102	140
50.175	39, 109	51.070	114	51.251	119	52.212	127	61.103	140

kod	strona	kod	strona	kod	strona	kod	strona	kod	strona
61.104	140	61.262	145	63.017	158	63.127.90.50	165	63.191.72.00	166
61.105	140	61.263	145	63.018	158	63.128.72.50	165	63.191.90.00	166
61.106	140	61.264	145	63.020	158	63.128.90.50	165	63.192.72.00	166
61.107	140	61.265	145	63.021	155	63.129.00.00	165	63.192.90.00	166
61.112	141	61.271	145	63.022	155	63.130.00.50	165	63.193.90.00	167
61.114	141	61.272	145	63.024	159	63.130.72.50	165	63.194.90.00	167
61.114.01	141	61.273	145	63.025	159	63.130.90.50	165	64.003	168
61.116	141	61.274	145	63.027	158	63.131.00.50	165	64.004	168
61.116.01	141	61.300	145	63.028	158	63.131.72.50	165	64.005	168
61.116.02	140	61.301	145	63.029	155	63.131.90.50	165	64.006	169
61.118	141	61.302	146	63.030	155	63.134.00.00	165	64.007	169
61.118.01	141	61.303	146	63.031	156	63.135.00.00	165	64.008	169
61.120	141	61.304	146	63.031.01	156	63.136.72.50	165	64.011	170
61.120.01	141	61.305	146	63.032	156	63.136.90.50	165	64.012	170
61.120.02	140	61.306	146	63.034	156	63.137.72.50	165	64.013	170
61.120.03	141	61.307	146	63.035	156	63.137.90.50	165	64.014	168
61.124	141	61.308	146	63.036	156	63.138.72.00	162	64.015	168
61.124.01	141	61.314	147	63.038	156	63.138.90.00	162	64.016	168
61.124.02	140	61.315	147	63.040	162	63.139.72.00	162	64.017	168
61.124.03	141	61.316	147	63.041	162	63.139.90.00	162	64.018	168
61.125	141	61.317	147	63.044	162	63.140.72.00	162	64.019	169
61.125.01	141	61.318	147	63.045	162	63.140.90.00	162	64.020	170
61.127	141	61.320	148	63.046	162	63.141.90.00	162	64.021	170
61.127.01	141	61.321	148	63.047	162	63.142	162	64.022	170
61.130	141	61.322	148	63.101.00.00	163	63.146.00.00	164	64.023	170
61.130.01	141	61.323	148	63.102.72.50	163	63.147.90.50	164	64.024	170
61.131	141	61.324	149	63.102.90.50	163	63.148.90.50	164	64.035	171
61.131.01	141	61.325	149	63.103.72.50	163	63.149.72.50	164	64.036	171
61.135	141	61.326	149	63.103.90.50	163	63.150.72.50	164	64.037	171
61.135.01	141	62.101	150	63.108.00.00	163	63.151.00.00	165	64.040	171
61.140	141	62.102	150	63.109.72.50	163	63.152.00.00	165	64.041	171
61.140.01	141	62.103	150	63.109.90.50	163	63.153.72.50	165	64.042	171
61.201	142	62.104	150	63.110.72.50	163	63.153.90.50	165	64.043	171
61.202	142	63.001	154	63.110.90.50	163	63.154.72.50	165	64.044	171
61.203	142	63.002	157	63.111.00.00	163	63.154.90.50	165	64.800	169
61.211	142	63.003	154	63.112.90.50	163	63.165.72.50	163	64.801	169
61.212	142	63.005	154	63.113.90.50	163	63.166.72.50	163	65.200	174
61.221.02	143	63.006	154	63.114.00.00	164	63.180.72.00	167	65.202	174
61.222.02	143	63.006.01	154	63.115.90.35	164	63.180.90.00	167	65.203	174
61.223.02	143	63.007	154	63.116.90.35	164	63.181.72.00	167	65.210	174
61.224.02	143	63.008	157	63.117.00.00	164	63.181.90.00	167	65.211	174
61.251	144	63.009	157	63.118.00.00	164	63.182.72.00	167	65.212	175
61.252	144	63.010	157	63.119.72.50	164	63.182.90.00	167	65.213	175
61.253	144	63.011	157	63.119.90.50	164	63.185.00.00	164	65.250	175
61.254	144	63.012	154	63.120.72.50	164	63.186.90.50	164	65.257.01	176
61.255	144	63.013	155	63.120.90.50	164	63.187.90.50	164	65.259	176
61.256	144	63.013.01	155	63.125.00.00	165	63.188.90.00	166	66.003.01	177
61.257	144	63.015	157	63.126.00.00	165	63.189.90.00	166	66.004.01	177
61.261	145	63.016	158	63.127.72.50	165	63.190.90.00	166	66.006.01	177

kod	strona	kod	strona	kod	strona	kod	strona	kod	strona
66.050	178	70.123	185	75.010	186	SPA.140.0242	194	TCI 125 10 22	196
66.051	178	70.222	184	75.013	186	SPA.140.0245	194	TCI 125 16 22	196
66.052	179	70.222.01	184	75.018	186	SPA.140.0253	194	TCI 125 25 22	196
66.053	179	70.222.02	184	75.025	187	SPA.140.0313	194	TCI 230 20 22	196
66.060	178	70.321	184	75.030	187	SPA.140.0379	194	TCI 230 30 22	196
66.070	179	70.321.01	184	75.041	187	SPA.140.0382	194	TCI 300 30 32	196
66.075	179	70.321.02	184	75.041.01	187	SPA.140.0387	194	TCI 350 35 32	196
<b>7xxxx</b>		70.322	184	<b>5xxxx</b>		SPA.140.0442	194	TCI 400 40 32	196
70.001	182	70.322.01	184	SP.001.08	190	SPA.140.0445	194	TLC 125 22 40	197
70.001.01	182	70.322.02	184	SP.001.08X	191	SPA.140.0587	194	TLC 125 22 60	197
70.001.02	182	70.323	185	SP.002.10	190	SPA.140.0590	194	TLC 125 22 80	197
70.002	182	70.323.01	185	SP.002.10X	191	SPA.141.0015	194	TLI 125 22 100	197
70.002.01	182	70.901	182	SP.003.12	190	SPA.142.0001	192	TLI 125 22 120	197
70.002.02	182	70.901.01	182	SP.003.12X	191	SPA.142.0003	192	TLI 125 22 40	197
70.003	182	70.901.02	182	SP.004.08X	191	SPA.142.0020	192	TLI 125 22 60	197
70.003.01	182	70.911	182	SP.005.10X	191	SPA.142.0022	192	TLI 125 22 80	197
70.021	184	70.911.01	182	SP.010.12	190	SPA.145.0075	193	TLIF 125 22 40	197
70.021.01	184	70.911.02	182	SP.011.10X	191	SPA.145.0076	193	TLP 125 22 40	197
70.021.02	184	71.001	186	SPA.002.0058	192	SPA.145.0078	193	TLP 125 22 60	197
70.022	184	71.300	186	SPA.002.0078 L	192	SPA.145.0080	193	TLP 125 22 80	197
70.022.01	184	71.410	186	SPA.003.0013	192	SPA.145.0085	193	TLS 125 22 100	197
70.022.02	184	71.410.01	186	SPA.012.0183	193	SPP.003.12X	191	TLS 125 22 120	197
70.101	183	71.410.02	186	SPA.014.0023	193	SWM.ADF.01	195	TLS 125 22 40	197
70.102	183	74.012	186	SPA.030.0145	193	SWM.INNER.01	195	TLS 125 22 60	197
70.103	183	74.015	186	SPA.140.0008	194	SWM.OUTER.01	195	TLS 125 22 80	197
70.104	183	74.015.01	186	SPA.140.0051	194	SWM.PRZYŁBICA.01	195	TLSF 125 22 40	197
70.105	183	74.020	186	SPA.140.0054	194	SWM.UCHWYT.01	195	TZI 125 60 22	197
70.121	185	74.112	186	SPA.140.0059	194	<b>7xxxx</b>		TZI 230 60 22	197
70.122	185	74.115	186	SPA.140.0114	194	TCI 115 10 22	196		

POSTAL  
STEEL GROUP  
BONMARIO 



**POSTAL**<sup>®</sup>  
STEEL GROUP

**BONMARIO** 

Postal Steel Group Polska Sp. z o.o.  
dawniej POSTAL STEEL GROUP Sp. z o.o. Sp. k.  
ul. Sowia 6 | „Sowia” Park Przemysłowy  
62-080 Tarnowo Podgórne, POLAND  
T: +48 61 65 25 900, +48 510 915 915  
zamowienia@postal.pl

[www.bonmario.com](http://www.bonmario.com)







**POSTAL**<sup>®</sup>  
STEEL GROUP

**BONMARIO** 

**PINOX**

**PSG**

**STAR**<sup>®</sup>  
**FLEX** 

**STAR**<sup>®</sup>  
**WIRE** 

**Platinum**

**POSTAL**<sup>®</sup>  
STEEL GROUP

[www.postal.pl](http://www.postal.pl)

